

WESTERN POWER DISTRIBUTION

Industrial and commercial design framework appendix to be read in conjunction with:

ENA Engineering Recommendation G81 Part 4 “Framework for design and planning, of industrial and commercial underground connected loads up to and including 11kV. Version agreed at Ofgem ECSG on 12th October 2004

WESTERN POWER DISTRIBUTION

INDUSTRIAL AND COMMERCIAL DESIGN FRAMEWORK DLH SPECIFIC APPENDIX

1.0 INTRODUCTION

- 1.1 Information contained in this Framework Appendix must be read in conjunction with the National Framework Documents, the Adoption Agreement, the other two Western Power Distribution (WPD) industrial and Commercial Framework Appendices relating to Installation and Materials and the WPD Framework Appendix on cable recording techniques. Please see the WPD Housing Development Installation Framework Document Appendix for full details on supplies to Multi-Occupancy buildings.
- 1.2 This document includes details of the more common arrangements for supplying industrial and commercial underground connected loads at up to and including 11kV. The maximum LV load is 1000kVA. Arrangements for HV connected load are typically via a tee off circuit breaker (equivalent to an fuse switch) or via a ring main unit, with or without HV metering unit, and these are illustrated in this Appendix. There are other HV arrangements which are sometimes used by WPD, involving duplicate supplies, some with “wing” metering, or circuit breaker switchboards, which for the purposes of this document we will term “complex”. The availability to employ such complex arrangements may be dependent upon other connection arrangements within the same feeder / ring. Because of this, and since other issues such as protection, ownership and control are also inter-dependent, it is best to discuss such proposed complex arrangements with the WPD Planner at the outset. They can then provide copies of the correct inter-related WPD documents.
- 1.3 In the event of query please speak to the WPD Planner acting as the focal point of contact for the scheme.

2.0 INFORMATION REQUIRED FROM APPLICANT WITH DESIGN

2.1 For each feeder –

- Number of Customers and connections on each phase
- Maximum feeder load in Amps
- Fuse selected and maximum clearance time – ph to earth fault at cut out
- Maximum voltage regulation at a cut out position + and - % at source end and at end of each mains tee.
- Maximum earth loop resistance, at end of each mains tee
- Maximum voltage unbalance %
- Diversity %
- Maximum length of cable in duct
- Maximum number of services from one mains joint

2.2 Demand assumptions

- a listing of demand profile classes + ADMDs/ annual consumption used for each category of service

Note - WPD set default in Windebut to a maximum of 0.25 Ohms, to allow for tolerances in impedances and lengths. Earth loop impedances which, on test, are found to exceed 0.35 Ohms will be rejected.

3.3 **Maximum design PSCCs at connection of service to main**

- 1ph 230v 16 kA
- 3ph 230/400v 25 kA
- 2ph 230/460v 25 kA

(these are due to the ratings of electrical equipment such as Consumer units)

3.4 **Losses**

WPD apply the following loss evaluation capitalised costs of losses in obtaining the “economic design” having regard to lifetime cost of losses -

HV/LV transformer –

variable loss £0.243 / Watt of transformer variable (Cu) loss at MD*

fixed loss £1.791 / Watt of transformer fixed (iron) loss*

*but subject to transformer losses not exceeding cap values stated in 3.10 below –

3.5 **LV mobile generation connections**

WPD have a requirement to provide means of connecting temporary LV 3 phase generation to the LV fuse cabinets at HV/LV substations. Please see the “Materials” DLH Specific appendix for further details.

3.6 **Services**

WPD do not employ or accept looped service connections. A maximum of four services (including street lighting etc) may be taken from any one mains joint.

3.7 Demands

ADMDs used in absence of customer classification / annual consumption data

New Domestic Connections	Day kW ADMD	Night kW ADMD
Gas Central Heating ^{1&2}	0.25 per Bedroom + 0.5	0.5 x day
No gas on site, Non Electric Central Htg ^{2&3}	0.5 per Bedroom + 1	0.5 x day
No gas on site, No Central Heating	4	2
Electric Heating, including Medallion & E7	0.6 x DA [#] + 2	0.8 x Off Peak Load* +0.5
Economy 7 Boilers:		
12 kW Boiler	7.5	19
16 kW Boiler (2/3 phase)	9.5	23
19 kW Boiler (2/3 phase)	11	26

1 Unrestricted, Low Consumption, up to 3000 kWh per year.

2 Unrestricted, Medium Consumption, 3001 - 7500 kWh per year.

3 Unrestricted, High Consumption, 7501+ kWh per year.

* Total Off Peak Heating, including water heating, typically 2 kW per bedroom + 6 kW

DA = Direct Acting electric heating.

ADMD = After diversity maximum demand

Maximum Demand = ADMD x Connections.

Use 15 kW as the minimum ADMD for the first connection in any group.

Table 2 - Existing Connections kW ADMD per 1000 kWh Annual Consumption	Day kW ADMD	Night kW ADMD
Unrestricted, non electric cooking	0.4	0.1
Unrestricted, electric cooking	0.5	0.1
Economy 7 Heating	0.6	1.2 ^{##}

kW per 1000 kWh annual night consumption

Use 15 kW as the minimum ADMD for the first connection in any group.

3.8 Voltage Unbalance -

Calculation of unbalance -

Percentage unbalance on a four wire LV system should be determined from the relationship:

$$\% \text{ unbalance} = \frac{I_N}{I_R + I_Y + I_B} \times 100$$

where I_N is the neutral conductor and I_R , I_Y and I_B are the currents in the three phase conductors.

Unbalance in a three wire system may be defined in terms of the ratio which the negative phase sequence component bears to the positive phase sequence component, a definition used for example in British Standards for Electric Motors. However, since means of directly measuring the NPS component of a system are not readily available, the following relationship should be used to provide a measure of unbalance as this will require the use of only normal voltmeters or ammeters.

$$\% \text{ unbalance} = \frac{\text{Maximum deviation from average of three individual values}}{\text{Average of three values}} \times 100$$

This will give a measure of unbalance of acceptable accuracy. The foregoing measure is used by NEMA (National Electrical Manufacturers Association) and has the advantage of more general acceptance.

3.9 Underground cable ratings -

General criteria for 11kV and LV cables (applies to both Paper, EPR and XLPE cables).

A winter soil resistivity of 0.9°Cm/W and a summer soil resistivity of 1.2°Cm/W is considered realistic for the South West and South Wales, although the possibility of localised higher values may need to be taken into account. To control the thermal resistivity of the surrounding medium then the best example would be to use cement bound sand (CBS) backfill for a cable route, but this is expensive. Generally crushed Limestone dust or crushed Granite dust 3mm to dust is suitable as this gives a Tr of 1.2°Cm/W .

Ground ambient temperatures across the South West and South Wales vary between 7°C in the winter and 15°C in the summer. These values apply in most locations, but winter ground temperatures in the city centres such as Bristol, Cardiff, Exeter, Plymouth and Swansea will be about 2°C higher.

The current ratings quoted in this document are maximum values.

The current ratings quoted apply to cables supplying loads, the maximum demand of which occurs between mid-November and the end of March.

The current ratings specified are to be adjusted where the conditions are known to vary from those quoted in this instruction i.e. high summer loads or grouping.

The maximum conductor temperature for paper cable is 65°C. The maximum conductor temperature for EPR and XLPE cables is 90°C.

When two or more cables or trefoil groups are laid in the same trench then a derating factor needs to be applied to both circuits. The amount of derating is dependant upon the spacing of the circuits. All spacing distances quoted in this document are **centre-to-centre** spacings of the cables or trefoil groups.

If the summer load of the circuit exceeds 75% of the winter load, the summer loading condition should also be considered.

All 11kV EPR triplex circuits are, for the purpose of this document, have been assumed to be three single-core cables laid touching, throughout their length, in trefoil formation. That the sheaths of the cables have been solidly bonded together and earthed at both ends of the circuit.

It should be noted that when triplex or single core cable, which has been laid in trefoil, a maximum of 12% of the TOTAL ROUTE LENGTH, can be laid in flat space configuration without affecting the trefoil rating. If more than 12% of the Total Route Length is laid in flat space configuration then high circulating currents will flow in the copper wire screens of the single core cables. This must be avoided. If the 12% cannot be achieved then contact the Company Cable Engineer at Avonbank.

Sustained, Continuous or Steady -State rating

The sustained rating is the maximum current that can be carried for a 24 hours a day, 7 days a week, in defined conditions, without the assumed maximum conductor temperature being exceeded.

Cyclic rating

A cyclic rating is the maximum current that maybe carried during the prolonged application of a succession of identical 24-hour load cycles, without the assumed maximum conductor temperature being exceeded.

Distribution rating

Distribution ratings are ratings calculated for stated conditions commonly occurring on distribution systems. The tabulated ratings given are 3 to 5 day limited time cyclic ratings.

Continued on next page

The basis of the Distribution ratings is given below: -

Quantity and value assumed in calculating Distribution Ratings	Conditions for which valid.
Assumed maximum conductor temperature	90°C
Depth of Laying 0.8m	Nominal laying depth, direct or in ducts.
Soil Ambient Temp. 10°C	Winter peak loads in UK.
Quantity and value assumed in calculating Distribution Ratings	Conditions for which valid.
Soil Thermal resistivity for cables laid direct or in ducts $g = 0.9^{\circ}\text{C}\cdot\text{m}/\text{W}$	(a) Summer load not greater than 75% of winter load. (b) Either special measures taken for difficult soils OR increased risk accepted.
Soil Thermal Diffusivity needed for transient conditions $0.5 \times 10^{-6} \text{ m}^2/\text{s}$	$G = 0.9^{\circ}\text{C}\cdot\text{m}/\text{W}$
Ambient conditions Cables in Air 10°C Solar gain neglected	(a) Maximum load in winter. (b) Heating from adjacent equipment not excessive. (c) Shielded from the sun.
Other Heat Sources None	No allowance made for grouping.
Cyclic Loading For cables laid direct or in ducts 24 hr load cycle.	Daily cyclic load typical domestic/commercial type.
Limited-time Rating Normal conditions restored after 3 – 5 days.	Two-feeder open-ring operation.

Utilisation Factor

The percentage of a cable's distribution rating which is not exceeded during its normal operational condition. Distribution ratings are based on an initial cable utilisation of 50%; if a circuit has a higher utilisation factor such as 75% then the Distribution rating must be reduced by 2.5%.

Load Factor

The ratio of the number of units supplied during a given period, to the number of units that would be supplied, had the maximum demand been maintained throughout that period. This is usually expressed as a percentage.

Soil thermal conductivity

The soil thermal conductivity is the thermal transmission in unit time through unit area of homogeneous soil of unit thickness, when unit difference of temperature is established between its surfaces.

Soil thermal resistivity

The ratings given are calculated for a damp thermal resistivity, which is suitable for rating cables for winter-peak loads.

Ground ambient temperature

Where a cable circuit carries a sustained load and does not have a seasonal variation it should be rated for the maximum summer value of ground temperature.

Ducts

A duct up to 15m in length can be used without derating the cable. Two or more duct lengths can be used on a section, provided that there is no more than 30m of duct in a particular 250m cable section and that there is a minimum of 10m separation between each duct length. See the example given below.

Example of two 15m-duct lengths in a 250m-cable section.

The duct rating shall be used if 15m or more of continuous duct is installed on a particular 250m-cable section.

The rating of the cable section can be restored if the ducts are bentonited after the cables have been installed. To ensure the thermal equivalence to the direct buried parts of the route, the ducts shall be completely filled with a bentonite-sand-cement mixture.

The filling medium shall be prepared by adding 20 parts of sand and 8 parts of cements, by weight, to 100 parts of a 10:1 water/bentonite mixture.

Note: The bentonite forms a gel, which is stabilized by the cement, and the addition of sand increases the load-bearing properties of the mixture. Should it be necessary to remove this mixture, it may be flushed out of the ducts by using high-pressure water jets.

Ducts, which are filled with a bentonite mixture, shall be installed wherever possible in a concrete surround but if not, any joints in the duct run must be effectively sealed. At the duct ends, the gap around the cable must be effectively sealed to prevent migration of the bentonite mixture and preserve its moisture content under service conditions.

In general duct lengths of up to 100m can be filled where a standard 150mm nominal bore duct is installed.

Cables exposed to the sun

To reduce the effect of solar radiation it is recommended that cables should be shielded from direct rays of the sun without restriction of ventilation.

Effects of grouping of cables

No allowance has been made for grouping in the ratings listed in the tables. Use the correction factors given in Table 1 for various grouping arrangements.

When two or more circuits of the same voltage are laid in close proximity the ratings of the cables must be reduced by multiply the group-rating factor given in Table 1 with the relevant cable rating selected from this document. It should be noted that if thermally independence of both the circuits is required, then the circuits need a centre-to-centre spacing of 2.5m.

All spacing quoted in Table 1, are a centre-to-centre spacing for the relevant circuits.

Loading Conditions

The ratings listed in this document are calculated for a particular typical domestic/commercial daily load curve, having a loss load factor of 0.5. See Figure 1 for the load curve.

Ratings given for cables installed in air and clipped direct to a wall are the steady-state ratings. Cables installed in this manner do NOT have a cyclic rating just their sustained or steady state rating.

Cables with High Summer Loads

If the summer load exceeds 75% of the winter load, the summer loading condition should also be considered. Conductor sizes should be based on whichever is found to be the more rigorous condition. See Table 2 for correction factors. The ratings of the cables must be reduced by multiply the correction factor given in Table 2 with the relevant cable rating selected from this document.

Tables and Ratings – are included in Annex A to this document

- 3.10 **HV/LV transformer ratings** – WPD employ unit type transformers to EATS 35-1 with standard ratings of 315, 500, 800 and 1000kVA. It is important to note that transformer noise limit criteria are included in EATS 35-1 but are not included in IEC 76. The **maximum** transformer losses currently accepted by WPD are –

Three phase-rating KVA	315	500	800	1000
No load loss W	609	765	1130	1304
Load loss W	4364	6236	9091	10727

- 3.11 **HV/LV substations** – WPD require all new HV/LV substations to be indoors. This is commonly achieved by use of a glass reinforced plastic housing to WPD specification (which includes reference to fire retardency, structural strength, ventilation and explosion relief, in addition to other aspects such as fittings). Please see “Materials” WPD Framework Document appendix for further details.

If a developer wishes to discuss an alternative to WPD specification g.r.p. housing, please discuss proposals with the WPD Planner for agreement.

WPD will consider alternative stand alone brick / block built indoor substations where a developer wishes to harmonise design with other buildings, but flat roof designs are not accepted.

Where it is proposed that the HV/LV substation is situated within a building also occupied by parties other than WPD, please see requirements set out in Annex B to this Appendix. There are two parts to this Annex – the first deals with Unit substation designs and the second with other HV switchrooms.

If a developer wishes to discuss an alternative to WPD specification g.r.p. housing, please discuss proposals with the WPD Planner for agreement.

In locations where there is a high risk of vandalism, additional measures may be required under the Electricity Safety, Quality and Continuity Regulations 2002. See DTI Guidance on The Electricity Safety, Quality and Continuity Regulations 2002 issued 22 October 2002 v1.

In very limited circumstances, typically in areas of outstanding natural beauty, or National Trust sites where a pole mounted unit would otherwise be employed, WPD have used individual installations of small capacity, up to 200kVA, pad mounted units to WPD specification. In such circumstances please discuss with WPD Planner.

3.12 **Standard schematic arrangements HV**

This section specifies standard switchgear, protection and metering arrangements used for HV connections to WPD's electricity system. (see comment in para 1.2)

All arrangements listed within this document assume that the load is balanced over three phases.

11kV switchgear and protection requirements are specified in EE:SPEC2 and EE:SPEC3 (as amended), which are based on ENA TS documents.. Non oil designs of switchgear are employed.

HV Metering CTs and VTs must be specified and tested in accordance with EE:SPEC2 and EE:SPEC3 (as amended), noting that the requirements of the Balancing & Settlement Code set accuracy requirements based on the capacity of the circuit and not the size of the load. Three copies of the test certificates shall be provided in advance of switchboard delivery.

Indoor accommodation for WPD's equipment is normally provided by the customer, free of charge. The Customer shall provide a 230V AC supply, suitable power points, lighting and heating with the substation. The Customer is responsible for the maintenance of the building and providing 24 hour access. All pertinent details regarding the building shall be included in the Connection Agreement.

A Connection Agreement, Responsibility Schedule, Supply Contract and Meter Operator Agreement must be in place and a Notice of Completion received by WPD before an HV connection can be energised.

In order to meet legal requirements and also to provide the Customer with a means of disconnecting the electricity supply, each standard arrangement includes:

- an isolatable fuse switch or automatic circuit breaker as close as reasonably practicable to the exit point
- an emergency, break glass, tripping system

The term 'Exit Point' has the same definition as 'supply terminals' included in the Electricity Safety Quality and Continuity Regulations 2002

Diagrams of the most common standard arrangements are listed in Annex C. In each case the Customer owns all the equipment beyond the Exit Point.

For simplicity, circuit breakers shown on the standard diagrams are displayed as SF6 filled circuit breakers. Vacuum types of circuit breaker, approved for use on Western Power Distribution's system, can also be used.

3.13 **Standard LV arrangements up to 1000kVA**

WPD employ 4 standard arrangements, which are described, together with cable types, ratings, metering requirements, mccbs and protection in Annex D.

LV Protection - The protection of LV feeder circuits shall meet the following requirements:

- Feeder circuits supplying more than one customer shall be protected by fuses.
- LV supply cables to single customers shall be protected by fuses or circuit breakers, dependent on supply capacity and customer's protection.
- Fuses must provide short-circuit protection for the whole length of the circuit and, ideally, for all services.
- Fuse ratings must allow for the cyclic overload rating of the circuit.
- For discrimination, the minimum pre-arcing I_t of a feeder circuit fuse must exceed maximum total I^2t of any fuses downstream.
- Design clearance time for LV phase to neutral faults (zero fault impedance) is 30 seconds maximum

3.14 **Provision for connecting LV generation to LV fuse boards / cabinets / pillars**

WPD as a standard require all new LV fuseboards, fuse cabinets and pillars to have facilities for allowing safe live connection of WPD standby LV generation. Details are included in the “Materials” WPD Framework Document Appendix.

TABLE 1

GROUP DERATING FACTORS FOR CIRCUITS OF THREE SINGLE-CORE CABLES, IN TREFOIL or LAID FLAT, HORIZONTAL FORMATION, LAID DIRECT.

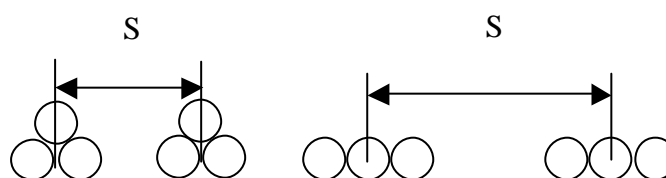

Type of Cable	No. of Circuits	Spacing of Circuits – Metre (S).					
		Touching		0.15	0.20	0.3	0.45
		Trefoil	Laid Flat				
LV Cables	2	0.77	0.80	0.82	0.84	0.88	0.90
	3	0.65	0.68	0.72	0.75	0.79	0.83
	4	0.59	0.63	0.62	0.67	0.75	0.81
	5	0.55	0.58	0.63	0.67	0.72	0.78
11kV Cables	2	0.78	0.80	0.81	0.82	0.85	0.88
	3	0.66	0.69	0.71	0.73	0.76	0.80
	4	0.60	0.63	0.65	0.67	0.72	0.76
	5	0.55	0.58	0.61	0.63	0.68	0.73
33kV Cables	2	0.79	0.81	0.81	0.83	0.85	0.88
	3	0.67	0.70	0.71	0.73	0.76	0.80
	4	0.62	0.65	0.65	0.67	0.72	0.76
	5	0.57	0.60	0.60	0.63	0.68	0.73

TABLE 2

CORRECTION FACTORS FOR CIRCUITS OPERATING WITH HIGH SUMMER LOADS

Cable Laid Direct: -

Cable Type	Sustained Rating Factor	Cyclic Rating Factor	Distribution Rating Factor
LV Cables	0.86	0.87	0.88
11kV 3 Core Cables	0.87	0.88	0.89
11kV Triplex	0.85	0.86	0.87
11kV Flat Spaced	0.85	0.86	0.86
33kV 3 core cables	0.86	0.90	0.91
33kV Trefoil	0.86	0.86	0.88
33kV Flat Spaced	0.86	0.86	0.87

Cables in Ducts: -

Cable Type	Sustained Rating Factor	Cyclic Rating Factor	Distribution Rating Factor
LV Cables	0.90	0.92	0.94
11kV & 33kV 3 Core Cables	0.91	0.93	0.95
11kV & 33kV Triplex, Trefoil.	0.92	0.90	0.92
11kV & 33kV Flat Spaced	0.90	0.91	0.93

Cables in Air and Clipped Direct: -

Cable Type	Sustained Rating Factor
All Cables	0.90

Figure 1 Load Curve

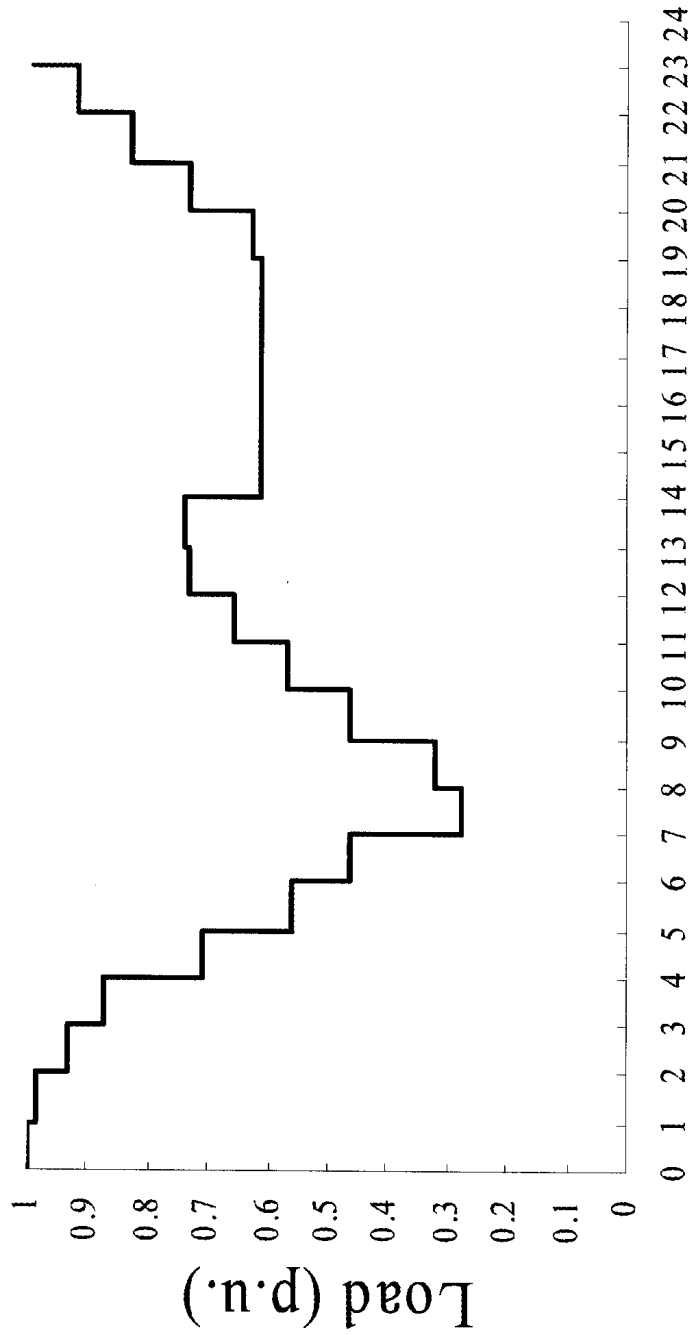

Time (Hours)

TABLE F1

**11kV CABLES (Picas) 3 CORE BELTED OIL IMPREGNATED PAPER INSULATED
CORRUGATED ALUMINIUM SHEATH**

Winter *SUSTAINED* Current Ratings

SIZE AND TYPE OF CABLE CONDUCTOR	SUSTAINED CURRENT RATINGS-AMPS		
	CABLE IN GROUND	CABLE IN DUCTS	CABLE IN AIR
95mm ² Al.	213	184	207
185mm ² Al.	314	268	314
300mm ² Al.	413	355	431

Parameters

Maximum depth of lay	0.8m
Soil Thermal Resistivity (g)	0.9°C m/W
Ground Ambient Temperature	10°C
Air Ambient Temperature	10°C
Maximum Conductor Temperature	65°C

Ratings based on EATS 09-12 Table 1.

TABLE F2

**11kV CABLES (Picas) 3 CORE BELTED OIL IMPREGNATED PAPER INSULATED
CORRUGATED ALUMINIUM SHEATH**

Winter *CYCLIC* Current Ratings

SIZE AND TYPE OF CABLE CONDUCTOR	CYCLIC CURRENT RATINGS-AMPS		
	CABLE IN GROUND	CABLE IN DUCTS	CABLE IN AIR
95mm ² Al.	240	190	207
185mm ² Al.	354	290	314
300mm ² Al.	466	395	431

Parameters

Maximum depth of lay	0.8m
Soil Thermal Resistivity (g)	0.9°C m/W
Ground Ambient Temperature	10°C
Air Ambient Temperature	10°C
Maximum Conductor Temperature	65°C
Cyclic Enhancement Factor	1.13

Ratings based on EATS 09-12 Table 1.

TABLE F3

**11kV CABLES (Picas) 3 CORE BELTED OIL IMPREGNATED PAPER INSULATED
CORRUGATED ALUMINIUM SHEATH**

Winter *DISTRIBUTION* Current Ratings

SIZE AND TYPE OF CABLE CONDUCTOR	DISTRIBUTION CURRENT RATINGS-AMPS		
	CABLE IN GROUND	CABLE IN DUCTS	CABLE IN AIR
95mm ² Al.	245	190	207
185mm ² Al.	370	290	314
300mm ² Al.	490	395	431

Parameters

Maximum depth of lay	0.8m
Soil Thermal Resistivity (g)	0.9°C m/W
Ground Ambient Temperature	10°C
Air Ambient Temperature	10°C
Maximum Conductor Temperature	65°C
Utilization factor	50%

Ratings based on Report 69-30 Table 7.

TABLE II

11kV SINGLE CORE (or triplex) E.P.R. INSULATED COPPER WIRE SCREEN & M.D.P.E. OUTER SHEATH CABLES, LAID IN TREFOIL. (Wet design)

Winter *SUSTAINED* Current Ratings

SIZE AND TYPE OF CABLE CONDUCTOR	SUSTAINED CURRENT RATINGS -AMPS		
	CABLE IN GROUND	CABLE IN DUCTS	CABLE IN AIR
<u>Metric sizes</u>			
<u>Copper conductors</u>			
300mm ² Copper	600	560	760
630mm ² Copper	850	750	1140
<u>Aluminium conductors</u>			
70mm ² Al.	210	215	240
95mm ² Al.	250	255	300
150mm ² Al.	320	315	380
185mm ² Al.	360	350	435
240 mm ² Al.	415	405	510
300mm ² Al.	475	455	600

Note: - These rating are suitable for 11kV XLPE of similar construction.

Parameters

Maximum depth of lay	0.8m
Soil Thermal Resistivity (g)	0.9°C m/W
Ground Ambient Temperature	10°C
Air Ambient Temperature	10°C
Maximum Conductor Temperature	90°C

Ratings based on Pirelli data sheets.

TABLE I2

11kV SINGLE CORE (or triplex) E.P.R. INSULATED COPPER WIRE SCREEN & M.D.P.E. OUTER SHEATH CABLES, LAID IN TREFOIL. (Wet design)

Winter *CYCLIC* Current Ratings

SIZE AND TYPE OF CABLE CONDUCTOR	CYCLIC CURRENT RATINGS -AMPS		
	CABLE IN GROUND	CABLE IN DUCTS	CABLE IN AIR
<u>Metric sizes</u>			
<u>Copper conductors</u>			
300mm ² Copper	678	633	760
630mm ² Copper	961	848	1140
<u>Aluminium conductors</u>			
70mm ² Al.	237	243	240
95mm ² Al.	283	288	300
150mm ² Al.	362	356	380
185mm ² Al.	407	396	435
240 mm ² Al.	469	458	510
300mm ² Al.	537	514	600

Note: - These rating are suitable for 11kV XLPE of similar construction.

Parameters

Maximum depth of lay	0.8m
Soil Thermal Resistivity (g)	0.9°C m/W
Ground Ambient Temperature	10°C
Air Ambient Temperature	10°C
Maximum Conductor Temperature	90°C
Cyclic Enhancement Factor	1.13

Ratings based on Pirelli data sheets.

TABLE I3

11kV SINGLE CORE (or triplex) E.P.R. INSULATED COPPER WIRE SCREEN & M.D.P.E. OUTER SHEATH CABLES, LAID IN TREFOIL. (Wet design)

Winter *DISTRIBUTION* Current Ratings

SIZE AND TYPE OF CABLE CONDUCTOR	DISTRIBUTION CURRENT RATINGS -AMPS		
	CABLE IN GROUND	CABLE IN DUCTS	CABLE IN AIR
<u>Metric sizes</u>			
<u>Copper conductors</u>			
300mm ² Copper	678	633	760
630mm ² Copper	961	848	1140
<u>Aluminium conductors</u>			
70mm ² Al.	237	243	240
95mm ² Al.	283	288	300
150mm ² Al.	362	356	380
185mm ² Al.	407	396	435
240 mm ² Al.	469	458	510
300mm ² Al.	537	514	600

Note: - These rating are suitable for 11kV XLPE of similar construction.

Parameters

Maximum depth of lay	0.8m
Soil Thermal Resistivity (g)	0.9°C m/W
Ground Ambient Temperature	10°C
Air Ambient Temperature	10°C
Maximum Conductor Temperature	90°C
Cyclic Enhancement Factor	1.13

Ratings based on ER P17 Part 3 Table 4-6.

TABLE K1

LV CABLES (Solidal) SINGLE CORE, ALUMINIUM CONDUCTOR, XLPE INSULATED, PVC SHEATHED AND ARMoured IN TREFOIL FORMATION

Winter *SUSTAINED* Current Ratings

SIZE AND TYPE OF CABLE CONDUCTOR	SUSTAINED CURRENT RATINGS-AMPS		
	CABLE IN GROUND	CABLE IN DUCTS	CABLE IN AIR
Metric			
<u>Aluminium conductors</u>			
480mm ² Al.	684	574	748
600mm ² Al.	752	618	839
740mm ² Al.	822	656	940
960mm ² Al.	907	713	1063

Parameters

Maximum depth of lay	0.5m
Soil Thermal Resistivity (g)	0.9°C m/W
Ground Ambient Temperature	10°C
Air Ambient Temperature	10°C
Maximum Conductor Temperature	90°C

Armour bonded and earthed at both ends

Metric sizes ratings based on ERA Report 69-30 part V Table 12 & 13

TABLE K2

LV CABLES (Solidal) SINGLE CORE, ALUMINIUM CONDUCTOR, XLPE INSULATED, PVC SHEATHED AND ARMoured IN TREFOIL FORMATION

Winter *CYCLIC* Current Ratings

SIZE AND TYPE OF CABLE CONDUCTOR	CYCLIC CURRENT RATINGS -AMPS		
	CABLE IN GROUND	CABLE IN DUCTS	CABLE IN AIR
Metric			
<u>Aluminium conductors</u>			
480mm ² Al.	772	648	748
600mm ² Al.	849	698	839
740mm ² Al.	928	741	940
960mm ² Al.	1024	805	1063

Parameters

Maximum depth of lay	0.5m
Soil Thermal Resistivity (g)	0.9°C m/W
Ground Ambient Temperature	10°C
Air Ambient Temperature	10°C
Maximum Conductor Temperature	90°C
Cyclic Enhancement Factor	1.13

Armour bonded and earthed at both ends

Metric sizes ratings based on ERA Report 69-30 part V Table 12 & 13

LV MAINS AND SERVICE CABLES**Winter *SUSTAINED* Current Ratings**

CABLE TYPE AND SIZE		SUSTAINED CURRENT RATING - AMPS		
		In Ground	In Single Way Ducts	In Air
WAVECON MAINS - 3 & 4 core.				
3 phase *	70mm ²	205	165	165
3 phase	95mm ²	249	198	205
3 phase *	120mm ²	283	231	235
3 phase	185mm ²	362	292	310
3 phase	300mm ²	475	385	425
* = No 4 Core wavecon of this size				
CONSAC				
3 phase	95mm ²	251	195	231
3 phase	185mm ²	369	289	349
SAC				
3 phase	95mm ²	257	211	240
3 phase	185mm ²	380	317	375
HYBRID SERVICE				
3 phase	25mm ²	99	82	86
3 phase	35mm ²	118	98	103
Single phase	25mm ²	118	96	99
Single phase	35mm ²	144	118	123
SPLIT COPPER CONCENTRIC				
3 phase	25mm ²	130	105	110
Single phase	16mm ²	115	96	97
Single phase	25mm ²	150	125	130
COPPER CONCENTRIC				
3 phase	16mm ²	113	92	96
3 phase	25mm ²	150	122	127
Single phase	16mm ²	113	92	96
Single phase	25mm ²	150	122	127
Single phase	35mm ²	190	140	166

Note: - For Welsh users '**Trydan**' is the same as Wavecon.

Parameters

Maximum depth of lay	0.45m
Soil Thermal Resistivity (g)	0.9°C m/w
Ground Temperature	10°C
Ambient Temperature	10°C
Maximum Conductor Temperature	90°C XLPE or 70°C PVC

LV MAINS AND SERVICE CABLES**Winter *CYCLIC* Current Ratings**

CABLE TYPE AND SIZE	CYCLIC CURRENT RATING - AMPS		
	In Ground	In Single Way Ducts	In Air
WAVECON MAINS – 3 & 4 core.			
3 phase * 70mm ²	231	188	165
3 phase 95mm ²	275	225	205
3 phase * 120mm ²	313	263	235
3 phase 185mm ²	400	331	310
3 phase 300mm ² * = No 4 Core wavecon of this size	525	438	425
CONSAC			
3 phase 95mm ²	284	220	231
3 phase 185mm ²	417	327	349
SAC			
3 phase 95mm ²	290	238	240
3phase 185mm ²	429	358	375
HYBRID SERVICE			
3 phase 25mm ²	111	92	86
3 phase 35mm ²	133	110	103
Single phase 25mm ²	133	108	99
Single phase 35mm ²	162	133	123
SPLIT COPPER CONCENTRIC			
3 phase 25mm ²	149	122	113
Single phase 16mm ²	130	108	85
Single phase 25mm ²	170	141	113
COPPER CONCENTRIC			
3 phase 16mm ²	113	93	85
3 phase 25mm ²	150	122	113
Single phase 16mm ²	113	93	85
Single phase 25mm ²	150	122	113
Single phase 35mm ²	215	158	166

Note: - For Welsh users '**Trydan**' is the same as Wavecon.

Parameters

Maximum depth of lay	0.45m
Soil Thermal Resistivity (g)	0.9°C m/W
Ground Temperature	10°C
Ambient Temperature	10°C
Maximum Conductor Temperature	90°C XLPE or 70°C PVC
Cyclic Enhancement Factor	1.13

FUNCTIONAL / PERFORMANCE SPECIFICATION FOR UNIT 11kV SUBSTATION CONSTRUCTION

Design/ Workmanship Generally:

The enclosure is to be designed and constructed by the Customer / Developer and is to provide a secure, internal, dry, stable, level, clean, dust-free, non-aggressive and non-hazardous environment to accommodate WPD equipment with minimised structure / fabric maintenance requirements.

The design life of the enclosure shall, as a minimum, be equivalent to the nominal life of the electrical plant / switchgear at 50 years. Building components where practicable shall be of a maintenance-free type or, at the least, of a low-maintenance type.

Detailed drawings and material specifications are to be submitted, by the Customer / Developer, to WPD for comment / agreement prior to submission for local authority consents and prior to the agreement of connection terms. All planning consents are to be obtained by the Developer / Customer.

All design / construction is to comply with the current edition of the Building Regulations.

Products to be incorporated into the construction shall be of a standard appropriate to the works (EC, BS, BBA certified), of consistent quality and appearance and installed in a workmanlike manner in accordance with good building practice.

The enclosure will typically accommodate the following electrical plant / equipment:

11,000/ 415 volt three phase transformer

11,000 volt circuit breaker/ ring main unit attached to transformer tank

415 volt fuse cabinet also attached to transformer tank

All HV switchgear, network HV supply cables, network LV cables and safety signage, will be supplied, installed, operated and maintained by Western Power Distribution (WPD).

All building /civil construction works described within this document, the connection agreement, or on the drawings, are to be provided by the Developer / Customer. The Customer has responsibility for carrying New Roads and Street Works Act searches enquiries as necessary to determine the presence, or otherwise of other utility asset in the vicinity of the proposed building works.

The minimum internal spatial dimensions and required substructure layout to conform with WPD cabling, operational and safety requirements (including means of escape) are indicated on drg no G4111.

Siting/Access Requirements:

WPD will require unrestricted 24 hour access to the enclosure.

All site access gates and the like are to be provided with a dual locking facility, incorporating a WPD substation security lock, or are to be opened by 24 hour on-site security staff.

For a free-standing enclosure, its walls should be positioned no closer than 1000mm from occupied buildings to minimise the potential risk of fire spread.

The enclosure shall be provided with an external access road / safe unloading area immediately in front of the entrance door(s) as follows:

The access road shall be a minimum of 3.0m wide, with 4.5m minimum headroom, and designed to accept a minimum weight of 13 tonnes.

The unloading area shall be a minimum of 3.0m x 3.0m, with 6.5m minimum headroom.

Both areas should be surfaced/ prepared/ maintained to such a standard that WPD light goods vehicles can readily access the site at all times (from initial installation to final decommissioning) without the need for special control measures.

External ground / access road levels shall be designed such that there is no hazardous / detrimental build up of surface water in the proximity of the enclosure to minimise the risk of flooding.

Where it is proposed to provide a dedicated substation enclosure within a larger building, the Customer shall ensure that access to the substation for the purpose of plant installation, maintenance and removal/ replacement is adequate. Two of the compartment walls forming part of the substation enclosure should be external walls and the substation floor should be notionally at ground floor level. The substation doors should be configured to open directly through the external envelope of the building at ground level, on to a level road/ accessway as detailed above. Consult WPD for detailed, project-specific access requirements.

The minimum internal spatial dimensions and required substructure layout shall correspond with those indicated on drg no G4111. Due consideration should be given to the use of mechanical lifting/ handling aids by WPD when installing equipment.

No gas / water / telecomm / other utilities fixtures are to be located within the substation enclosure.

Loading/ Structural Issues:

The enclosure shall be designed in accordance with the codes of practice relevant to the proposed structural materials and shall adequately carry and transmit to the natural foundation all dead, imposed and wind loads (including adverse combinations) with due regard to deformation, structural stability, subsoil conditions / effects and the proximity of adjacent structures.

Details of the dead loads imparted to the substructure by WPD electrical plant are indicated on drawing no G4111.

The evaluation of loads other than those specified for the electrical plant / equipment manufacturer(s) shall be in accordance with appropriate British Standards for the assessment of dead and imposed, wind and snow loads.

Where the enclosure is to be constructed within a larger building, it is essential that its walls, roof/ ceiling and floor offer no structural support to the components of the main building.

There is a conceivable risk that in the unlikely event of an internal fault within the WPD plant, a controlled venting of over-pressure may occur. This overpressure may have an adverse effect upon the structural elements forming the substation enclosure. It is essential that any resulting structural distress does not adversely affect the structural integrity/ robustness of the main building.

Fire Resistance:

The equipment contained within the substation should be seen as a potential source of combustion.

The enclosure shall be of fire resistant construction and designed to ensure that in the event of fire the structure is not materially impaired and the spread of fire (and smoke where applicable) is restricted over internal surfaces and not to other buildings / adjacent structures.

Where the substation is to be accommodated within a larger building, the fire resistance of the HV substation compartment constructed by the Customer shall be appropriate to ensure Building Regulations/ Fire Authority approvals.

The Customer will be required to advise WPD of any specific requirements for the use of intumescent seals/ pillows/ blankets etc necessary to ensure the integrity of the fire compartment.

The Customer should make provision for the extension of existing, or provision of new, smoke/ heat sensors to the WPD substation linked to a fire alarm panel with internal/ external sounders and remote monitoring as necessary.

Durability / Moisture Resistance:

The enclosure shall be designed to protect the structure and its contents from damage or risks to health and safety due to the effects of weather, water / moisture penetration and ground contaminants.

Generally, flat roof construction is unacceptable for WPD substations. Customers proposals should incorporate a roof fall of at least 5 degrees (measured from the horizontal).

Ventilation:

The enclosure shall be designed to provide adequate ventilation and to prevent adverse levels of condensation or gas concentrations likely to cause damage to the fabric of the structure and its contents or pose a risk to health and safety.

No air conditioning/ cooling plant shall be installed within the substation as natural ventilation via the grilles specified on the drawings will suffice.

Secure ventilation openings / secure grilles are to be provided, at low and high level. See drg G4111 for details.

Drainage:

The enclosure shall be designed to adequately collect and convey surface / storm water to a suitable point of disposal.

Security:

The enclosure shall be constructed with no areas of glazing and designed to prevent any unauthorised entry or access to the electrical plant / equipment. Appropriate safety / warning / danger signs and notices (provided and installed by WPD) shall be permanently displayed.

All entrance doors shall be outward opening, of robust / vandal resistant / durable / maintenance-free steel, hardwood or g.r.p. construction and fitted with a secure locking arrangement capable of receiving a 'Union' 1x1 cylinder (with a 6-pin tumbler) which will be supplied and fitted by WPD. Alternatively, with express WPD consent, a heavy-duty hasp and staple may be fitted to receive a suited WPD padlock.

Double leaf entrance doors shall be designed such that the right hand leaf (viewed from outside) will open first. The meeting stiles shall be rebated / overlap or otherwise be resistant to prising. The left hand leaf shall be fixed internally by short top and bottom sliding bolts into receptors within the frame head and cill.

Heavy duty door restraints shall be fitted at the head of each door leaf and shall be capable of holding the doors open at 90 degrees.

All door hinges shall be vandal resistant / heavy duty with concealed fixings.

L.V. Electrical:

The heating, lighting and power requirements are indicated on drg no G4111.

As a minimum, the substation is to be provided with a two-way MCB consumer unit (fed from Customers LV network), light fittings switchable from inside the entrance door(s) and a 13A double socket incorporating a 30mA residual current device (RCD).

All wiring shall be run in galvanised steel conduit. All switch boxes, sockets and the like are to be of a heavy duty metal-clad type.

The design and installation shall incorporate recommendations, where applicable, contained within BS 7671 'Requirements for Electrical Installations' (The IEE Wiring Regulations).

FUNCTIONAL / PERFORMANCE SPECIFICATION FOR HIGH VOLTAGE (11000 volts) SWITCHROOM

Design/ Workmanship Generally:

The HV Switchroom is to be designed and constructed by the Customer / developer and is to provide a secure, internal, dry, stable, level, clean, dust-free, non-aggressive and non-hazardous environment to accommodate WPD equipment with minimised structure / fabric maintenance requirements.

The design life of the HV switchroom shall, as a minimum, be equivalent to the nominal life of the electrical plant / switchgear at 50 years. Building components where practicable shall be of a maintenance-free type or, at the least, of a low-maintenance type.

Detailed drawings and material specifications are to be submitted, by the Customer, to WPD for comment / agreement prior to submission for local authority consents and prior to the agreement of connection terms. All planning consents are to be obtained by the Customer.

All design / construction is to comply with the current edition of the Building Regulations.

Products to be incorporated into the construction shall be of a standard appropriate to the works (EC, BS, BBA certified), of consistent quality and appearance and installed in a workmanlike manner in accordance with good building practice.

The HV Switchroom will typically accommodate a free-standing 11,000 volt circuit breaker/ ring main unit.

All HV switchgear, network HV supply cables and safety signage, will be supplied, installed, operated and maintained by WPD.

Private HV cables, general LV wiring/ switching and heating/ lighting/ power fittings, will be supplied and installed, as indicated on the drawings, by the Customer.

All building /civil construction works described within this document, the connection agreement, or on the drawings, are to be provided by the Customer. The Customer has responsibility for carrying out New Roads and Street Works Act searches/ enquiries as necessary to determine the presence, or otherwise of other utility asset in the vicinity of the proposed building works and utility constraints/ restrictions associated with their asset.

The minimum internal spatial dimensions and required substructure layout for the HV Switchroom to conform with WPD cabling, operational and safety requirements (including

means of escape) are indicated on drg no G4074.

A metering room shall be provided within a maximum distance of 10 metres from the HV Switchroom. A suitable layout for the metering room is indicated on drawing no G4074 but the Customer should consult his appointed meter operator to confirm requirements. A clear duct run of a minimum diameter of 100mm shall be provided between the HV Switchroom and the metering room for the installation of multi-core cabling. All bends in duct runs shall be smooth and a pair of draw wires will be installed to the duct run.

An emergency trip button, of a break-glass type shall be provided within the metering room (or other location to WPD approval) and shall be clearly identifiable.

Siting/ Access Requirements:

WPD will require unrestricted 24 hour access to the HV switchroom.

All site access gates and the like are to be provided with a dual locking facility, incorporating a WPD substation security lock, or are to be opened by 24 hour on-site security staff.

For a free-standing enclosure, its walls should be positioned no closer than 1000mm from occupied buildings to minimise the potential risk of fire spread to/ from the structure.

The HV switchroom shall be provided with an external access road / safe unloading area immediately in front of the entrance door(s) as follows:

The access road shall be a minimum of 3.0m wide, with 4.5m minimum headroom, and designed to accept a minimum weight of 13 tonnes.

The unloading area shall be a minimum of 3.0m x 3.0m, with 6.5m minimum headroom to allow for mechanical lifting.

Both areas should be surfaced/ prepared/ maintained to such a standard that WPD light goods vehicles can readily access the site at all times (from initial installation to final decommissioning) without the need for special control measures.

External ground / access road levels shall be designed such that there is no hazardous / detrimental build up of surface water in the proximity of the enclosure to minimise the risk of flooding.

Where it is proposed to provide a dedicated substation enclosure within a larger building, the Customer shall ensure that access to the substation for the purpose of plant installation, maintenance and removal/ replacement is adequate. At least one of the compartment walls

forming part of the substation enclosure should be an external wall and the substation floor should be notionally at ground floor level. The substation doors should be configured to open directly through the external envelope of the building at ground level, on to a level road/ accessway as detailed above. Consult WPD for detailed, project-specific access requirements.

The minimum internal spatial dimensions and required substructure layout shall correspond with those indicated on drg no G4074. Due consideration should be given to the use of mechanical lifting/ handling aids by WPD when installing equipment.

No gas / water / telecomm / other utilities fixtures are to be located within the substation enclosure.

Loading/ Structural Issues:

The HV switchroom shall be designed in accordance with the codes of practice relevant to the proposed structural materials and shall adequately carry and transmit to the natural foundation all dead, imposed and wind loads (including adverse combinations) with due regard to deformation, structural stability, subsoil conditions / effects and the proximity of adjacent structures.

Details of the dead loads imparted to the substructure by WPD electrical plant are indicated on drawing no G4074.

The evaluation of loads other than those specified for the electrical plant / equipment manufacturer(s) shall be in accordance with appropriate British Standards for the assessment of dead and imposed, wind and snow loads.

Where the enclosure is to be constructed within a larger building, it is essential that its walls, roof/ ceiling and floor offer no structural support to the components of the main building.

There is a conceivable risk that in the unlikely event of an internal fault within the WPD plant, a controlled venting of over-pressure may occur. This overpressure may have an adverse effect upon the structural elements forming the substation enclosure. It is essential that any resulting structural distress does not adversely affect the structural integrity/ robustness of the main building.

Fire Resistance:

The equipment contained within the substation should be seen as a potential source of combustion.

The HV switchroom shall be of fire resistant construction and designed to ensure that in the event of fire the structure is not materially impaired and the spread of fire (and smoke where

applicable) is restricted over internal surfaces and not to other buildings / adjacent structures. All doors, frames and fittings shall be designed to open outwards and to provide a minimum fire resistance of 1 hour.

Where the Switchroom is to be accommodated within a larger building, the fire resistance of the HV Switchroom compartment constructed by the Customer shall be appropriate to ensure Building Regulations/ Fire Authority approvals.

The Customer will be required to advise WPD of any specific requirements for the use of intumescent seals/ pillows/ blankets etc necessary to ensure the integrity of the fire compartment.

The Customer should make provision for the extension of existing, or provision of new, smoke/ heat sensors to the WPD substation linked to a fire alarm panel with internal/ external sounders and remote monitoring as necessary.

Durability / Moisture Resistance:

The HV switchroom shall be designed to protect the structure and its contents from damage or risks to health and safety due to the effects of weather, water / moisture penetration and ground contaminants.

Generally, flat roof construction is unacceptable for WPD substations. Customers proposals should incorporate a roof fall of at least 5 degrees (measured from the horizontal).

Ventilation:

The HV switchroom shall be designed to provide adequate ventilation and to prevent adverse levels of condensation likely to cause damage to the fabric of the structure and its contents or pose a risk to health and safety.

In the absence of detailed design data, the Customer is to afford ventilator grilles/ trickle vents/ other proprietary ventilators in accordance with the current edition of the Building Regulations.

No air conditioning/ cooling plant shall be installed within the substation.

Drainage:

The HV switchroom shall be designed to adequately collect and convey surface / storm water to a suitable point of disposal.

Thermal Performance / Insulation:

The HV switchroom shall be designed to limit heat losses through the fabric of the building.

Security:

The HV switchroom shall be constructed with no areas of glazing and designed to prevent any unauthorised entry or access to the electrical plant / equipment. Appropriate safety / warning / danger signs and notices (provided and installed by WPD) shall be permanently displayed.

All entrance doors shall be outward opening, of robust / vandal resistant / durable / maintenance-free steel, hardwood or g.r.p. construction. The HV Switchroom doors shall be fitted with a secure locking arrangement capable of receiving a 'Union' 1x1 cylinder (with a 6-pin tumbler) which will be supplied and fitted by WPD. The metering room shall be provided with a locking arrangement to that affords access to the Customer, Meter Operator and Data Retriever.

Double leaf entrance doors shall be designed such that the right hand leaf (viewed from outside) will open first. The meeting stiles shall be rebated / overlap or otherwise be resistant to prising. The left hand leaf shall be fixed internally by short top and bottom sliding bolts into receptors within the frame head and cill.

Heavy duty door restraints shall be fitted at the head of each door leaf and shall be capable of holding the doors open at 90 degrees.

All door hinges shall be vandal resistant / heavy duty with concealed fixings.

L.V. Electrical:

The heating, lighting and power requirements are indicated on drg no G4074.

As a minimum, the Switchroom is to be provided with a two-way MCB consumer unit (fed from Customers LV network), light fittings switchable from inside the entrance door(s), a 13A double socket incorporating a 30mA residual current device (RCD) and thermostatically controlled tubular heater. LV equipment requirements for the Metering Room are indicated on the drawing although these should be clarified with the Meter Operator.

All wiring shall be run in galvanised steel conduit. All switch boxes, sockets and the like are to be of a heavy duty metal-clad type.

The design and installation shall incorporate recommendations, where applicable, contained within BS 7671 'Requirements for Electrical Installations' (The IEE Wiring Regulations).

Arrangement No 1 - Ring Main Unit (RMU) + Metering Unit

Arrangement No 1 is suitable for loads up to 200A (3800kVA at 11kV or 2200kVA at 6.6kVA). The ring switches are rated at 630A and the tee off circuit breaker 200A.

11kV loads up to 1900kVA and 6.6kV loads up to 1100kVA will normally be protected by a Time Lag Fuse (TLF) operated circuit breaker. For higher loads, an approved, self-powered relay, for example the VIP300, shall be installed.

Where the metering circuit breaker is connected directly to a single transformer, it can provide the transformer HV protection. The maximum size of transformer which can be protected by TLFs is 1500kVA at 11kV and 1000kVA at 6.6kV.

The metering circuit breaker cannot provide transformer protection where the Customer has more than one transformer. In such cases the Customer shall install additional HV switchgear and protection.

Supplies provided to mines or quarries may require sensitive earth fault (SEF) protection to be included (see Section 7). Arrangement 1 (M&Q) can be used where SEF is required.

If the customer operates embedded generation in parallel with WPD's system, neutral voltage displacement (NVD) protection may be required (see Section 8). NVD protection requires a 3 phase, 5 limb VT (or three, single phase VT'S), with an open delta winding. Arrangement 1(G) can be used where NVD is required.

Arrangement No 2 - Extensible Switchgear, Single Bus bar Connection

Arrangement No 2 is suitable for loads up to 400A (7600kVA at 11kV or 500kVA at 6.6kVA). The ring switches shall be rated at 630A and the busbar metering circuit breaker at either 200A or 630A as required.

Physical segregation between WPD and Customer owned equipment is normally achieved by the installation of a wire mesh screen. Where necessary a busbar extension can be installed to allow the wire mesh screen to be fitted. Alternatively the wire mesh screen may include a removable panel which can be taken out / opened by WPD (but not by the Customer) to allow access to the metering circuit breaker.

Only one version is provided in the Standard Arrangements. It is assumed that where extensible switchgear is required this will connect to a Customer owned HV switchboard. An approved protection relay, rather than TLFs is provided on the metering circuit breaker to grade with the customer's protection. It is also assumed that the Customer will provide NVD or SEF protection where needed.

Arrangement No 3 - Free-standing 200A Circuit Breaker, Single Circuit Connection

This arrangement can supply load up to 200A (3800kVA at 11kV and 2200kVA at 6.6kVA). The free standing circuit breaker is rated to 200A.

Loads up to 100A (1900kVA at 11kV and 1100kVA at 6.6kV) will normally be protected by a Time Lag Fuse (TLF) operated circuit breaker. For higher loads, an approved self-powered relay, for example the VIP300, shall be installed.

Where the metering circuit breaker is connected directly to a single transformer, it can provide the transformer HV protection. The maximum size of transformer which can be protected by TLFs is 1500kVA at 11kV and 1000kVA at 6.6kV.

The metering circuit breaker cannot provide transformer protection where the Customer has more than one transformer. In such cases the Customer shall install additional HV switchgear and protection.

Supplies provided to mines or quarries may require sensitive earth fault (SEF) protection to be included (see Section 7). Arrangement 3(M&Q) can be used where SEF protection is required.

If the Customer operates embedded generation in parallel with Western Power's Distribution system, neutral voltage displacement (NVD) protection may be required (See Section 8). NVD protection requires a 3 phase, 5 limb VT (or three, single phase VTs), with an open delta winding. Arrangement 1(G) can be used where NVD is required.

Metering

The ownership, operating and maintenance responsibilities for metering equipment are split between the Meter Operator and WPD's distribution business. The Customer may appoint Western Power Distribution as the Meter Operator. Further information is provided below.

The Meter Operator owns, operates and maintains the

- meters
- meter control equipment
- test terminal block, if the safe access terminal block (SATB) is not suitable for test purposes
- fuses and links within the meter panel beyond the multicore termination
- communication equipment, if required

WPD's distribution business owns, operates and maintains the

- CTs and VTs

- metering unit
- switchgear
- multicores
- fuses and links outside the meter panel
- multicore termination block, SATB or fuses and links
- the cubicle which contains the multicore termination block, SATB and/or fuses and links. This is normally the meter panel itself.

Multicores are usually terminated within the meter panel. Normally the CT wiring is terminated on an extra SATB and the VT wiring on a set of fuses and/or links. These form the ownership boundary between the Meter Operator and Western Power Distribution.

Meter panels shall be installed within a 'walk in' building or weatherproof enclosure. A separate panel is installed for each circuit to be metered, each requiring a minimum space of 1m x 1m x 1.5m (depth). Meters shall be mounted at roughly 'eye-level'. To achieve this, the top of each panel should be approximately 1.8m above the floor level.

Standard Metering CT ratios included in this document are in accordance with ENA Technical Specification 41-36. The specification and testing requirements of metering CTs and VTs are included in EE:SPEC2 and EE:SPEC3 (as amended). Test Certificates shall be provided for all windings in advance of the delivery of the equipment.

Where the circuit capacity (the rating of the equipment), irrespective of the load requested by the Customer is over 10MVA then the requirements for metering CTs and VTs are enhanced. Above this capacity the accuracy class for both CTs and VTs is increased and specification for VT check windings changes. Care must be taken to ensure the correct CTs and VTs are purchased. Full details are included in EE:SPEC2 and EE:SPEC3 (as amended).

PVC insulated multicore cables complying with ENA Technical Specification 09-6 shall be used to connect between the metering panel and switchgear. Where the total multicore length exceeds 10 metres the cores shall be doubled up to reduce impedance. Under no circumstances shall the multicore be longer than 20 metres.

LIAISON WITH THE METER OPERATOR

The Customer or Supplier have the right to appoint their own Meter Operator. The Customer must enter into a Meter Operator Agreement.

Any physical changes to the metering equipment, for example changes to the CT ratios, meters, meter positions, VT's, switchgear etc, must be notified by the planner to the Meter Operator at least three weeks in advance of any change to the metering arrangement.

EMERGENCY TRIPPING

All the standard arrangements described in this document provide the Customer with a means of switching off the incoming electricity.

The emergency tripping system shall be designed to disconnect the incoming source of electricity. If Customer generation is installed this may need to be prevented from operating by the emergency tripping system.

WPD's standard trip unit consists of a push button switch installed within a box fitted with a 'break glass' cover. The switch has two contacts, one normally open and one normally closed. Operation of the trip button will energise the metering circuit breaker trip coil, opening the breaker. The trip coil is either energised from the metering VT or from a DC supply owned and maintained by WPD. The normally closed contact may be used to inhibit the operation of customer owned generation. Where this is the case a label shall be fitted stating "More Than One Source Of Supply".

Under no circumstances shall the circuit breaker trip coil be connected to more than one auxiliary supply.

The trip button shall be located in a position which is easily accessible by the Customer. Multicores used to connect between the emergency trip button, switchgear and trip supply shall have a maximum length of 50m. Multicores used for this purpose shall meet the requirements of ENA Technical Specification 09-6.

A standard emergency trip button is normally provided by WPD. As an alternative, the Customer may provide, install and pay for an emergency trip button to their own specification.

In some cases Customers may wish to trip WPD's metering circuit breakers from their protection equipment or from an additional emergency trip button. This can lead to confusion over the ownership of the equipment and increase the length and complexity of trip supply wiring. In order to minimise the risk to WPD, Customer owned protection may only trip the metering circuit breaker if all of the following conditions are met:

- i) Only circuit breakers shall be tripped by Customer protection.
- ii) The circuit breaker shall be tripped from a hand reset trip relay meeting the requirements of IEC 60255, wired in parallel with the emergency trip button. The Customer's trip relay shall be located on a panel close to the emergency trip button and arranged to minimise the chance of damage to the trip supply wiring.
- iii) The trip relay and associated panel shall be provided, installed and owned by the Customer.

- iv) The operating coil of the trip relay shall be energised from the Customer's supply.

Standard emergency trip button and trip arrangement diagrams are shown in the attached drawings

MINES AND QUARRIES

Guidance on the use of electricity at mines and quarries is provided in the two Health and Safety Executive (HSE), Approved Code of Practices (ACOP), listed below.

- i) The Use of Electricity at Quarries
- ii) The Use of Electricity in Mines

Responsibility for meeting the requirements of these documents lie with the employer, manager and where appropriate, employees at the mine or quarry.

The following statements, referring to earth leakage protection for supplies above 650V, appear in both ACOPs.

"For power systems with their reference connected solidly to earth the maximum value of trip settings should not exceed 5 amperes, or 15% of the rated load current, whichever is the greater."

"The settings of leakage fault protection devices in the switchgear controlling the circuit should be selected to ensure effective operation. Leakage fault protection may not be effective if the ratio between the maximum prospective earth fault current and that required to operate the tripping mechanism is less than 3:1 and a value of at least 5:1 is preferable."

Provision of earth leakage protection to meet the above requirements is the responsibility of the Customer. In most cases the Customer can easily provide this protection but where WPD's metering circuit breaker provides the customer's only HV protection then sensitive earth fault (SEF) protection can be provided by WPD.

Arrangements 1(M) and 3(M) should be used for this type of application.

BATTERY SYSTEMS

Arrangements 1(M&Q), 1(G), 3(M&Q), 3(G), 4 and 5 all require a DC battery and battery charger to be installed. The battery system is used to power some of the protection relays and to provide circuit breaker tripping facilities. The latest issue of EE:SPEC:24, shall be used to specify the battery system requirements.

Battery systems which are used to power WPD protection equipment or to trip WPD switchgear shall be owned and maintained by WPD.

In some cases both the Customer and WPD will require a DC supply. In practice it may be sensible for the customer to derive their DC supply from the WPD battery system. This is only acceptable if the Customer has only a small amount of equipment requiring a DC supply and all the following requirements are met

- i) The Customer's equipment is located in the same or adjacent room to that containing WPD's battery system.
- ii) The battery system is sized to take account of the Customer's equipment
- iii) The Customer's load is fused separately to WPD's load. The scheme shall be designed so that faults on the Customer's DC wiring shall not blow fuses supplying WPD's equipment.

EARTHING

The earthing requirements at HV connections are similar to those at any WPD 11kV/415V substation. The HV earth resistance and the thermal requirements of the earthing shall be assessed and designed in the same manner as any distribution transformer.

WPD shall install HV earthing for the incoming switches, bonded to the HV metalwork and arranged to prevent dangerous step, touch and transfer voltages occurring. HV cable sheaths should normally be bonded to the HV metalwork/earthing system.

The Customer is responsible for designing and providing their own HV and LV earthing systems, although in practice it is normal to bond the Customer and WPD HV earths together to reduce the earth resistance. The Customer must ensure that LV and HV earthing is segregated unless it can be shown that the combined resistance is less than 1 ohm and the potential rise under earth fault conditions is less than 430V. Guidance on assessment of earth potential rise is provided in ST:TP21E (to be issued) and by the Primary Design Section. In general, where there is not a continuous metallic path back to the primary substation, the earth potential rise may exceed 430V. This will depend on the relative earth resistances at cable ends and also the cable sheath type.

Where HV and LV segregation is required, care must be taken to ensure that a minimum distance of 2m above ground is maintained between HV metalwork and any LV bonded metalwork to prevent anyone touching both earth references simultaneously. The standard segregation distance of 9m below ground is also required between the HV and LV earthing electrodes.

Further guidance on earthing issues is provided in the Manual of Earthing Practices, POL:TP21 and its associated Standard Techniques.

KEY TO STANDARD ARRANGEMENTS

PROTECTION RELAY SYMBOLS USED IN
STANDARD ARRANGEMENTS

2OC IT	2 PHASE - INVERSE TIME OVERCURRENT PROTECTION (ALSO USED FOR TIME LAG FUSE OVERCURRENT)
E IT	INVERSE TIME EARTH FAULT PROTECTION (ALSO USED FOR TIME LAG FUSE EARTH FAULT)
SEF	SENSITIVE EARTH FAULT PROTECTION
NVD	NEUTRAL VOLTAGE DISPLACEMENT PROTECTION
TH	HAND RESET TRIP RELAY
2DOC IT	2 PHASE - DIRECTIONAL OVERCURRENT PROTECTION
DE IT	DIRECTIONAL EARTH FAULT PROTECTION

2	RJB		1/00	TITLE BLOCK CHANGE
Rev No	Drawn	Chk'd	App'd	Date
ORIGINAL ISSUE			DATE	
Drawn	RJB	10/99		
Checked				
Approved				
SCALE	N.T.S.			
WESTERN POWER DISTRIBUTION Design Department Avonbank, Feeder Road, Bristol BS2 0TB Tel: 0117 933 3000 Fax: 0117 933 3001				WESTERN POWER DISTRIBUTION
Title				Drg. No.
PROTECTION RELAY SYMBOLS				06/69/2889/0
				Rev No
				2

ALL RIGHTS ARE RESERVED TO SINE plc. NO PART OF THIS DRAWING MAY BE REPRODUCED OR TRANSMITTED IN ANY FORM OR BY ANY MEANS, INCLUDING PHOTOCOPYING AND RECORDING, OR STORED IN A RETRIEVAL SYSTEM OF ANY NATURE, WITHOUT PERMISSION.

ARRANGEMENT No 1

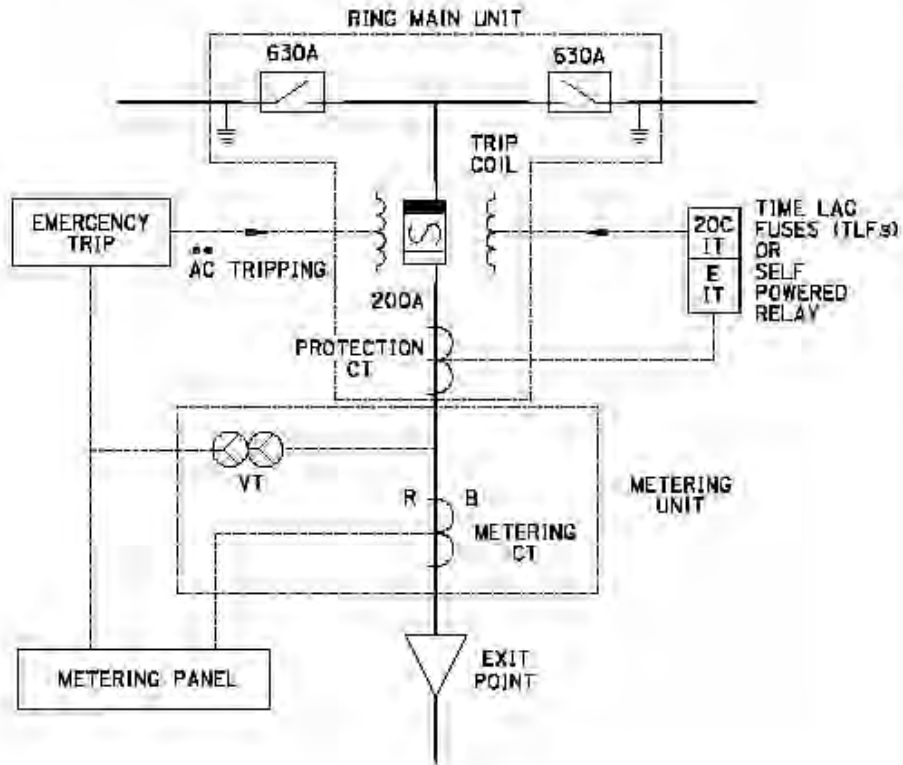

6.6kV LOAD kVA	11kV LOAD kVA	METERING CT RATIO (A) CLASS 0.5B	PROTECTION CT RATIO	PROTECTION TYPE
100 - 570	100 - 950	100/50/5	100/50/5	TLF
570 - 1100*	950 - 1900*	100/50/5	100/50/5	TLF
1100 - 2200	1900 - 3800	200/100/5	200/1	SELF POWERED RELAY

* SEE SECTION 3 FOR TRANSFORMER PROTECTION RESTRICTIONS

** AC TRIPPING SUPPLY IS DERIVED FROM THE METERING VT

11	RJB			7/00	TEXT ADDED		
Rev No	Drawn	Chk'd	App'd	Date		Revision	
ORIGINAL ISSUE	DATE	WESTERN POWER DISTRIBUTION Design Department Avenbank, Fetter Road, Bristol BS2 0TD Tel: 0117 999 2000 Fax: 0117 999 2001				WESTERN POWER DISTRIBUTION	
Drawn	RJB	7/98			Title	Drq. No.	Rev No.
Checked					RING MAIN UNIT	06/69/2889/1	11
Approved							
SCALE	N.T.S.						

ALL RIGHTS ARE RESERVED TO SMC PLC. NO PART OF THIS DRAWING MAY BE REPRODUCED OR TRANSMITTED IN ANY FORM OR BY ANY MEANS, INCLUDING PHOTOCOPYING AND RECORDING, OR STORED IN A RETRIEVAL SYSTEM OF ANY NATURE, WITHOUT PERMISSION.

ARRANGEMENT No 2

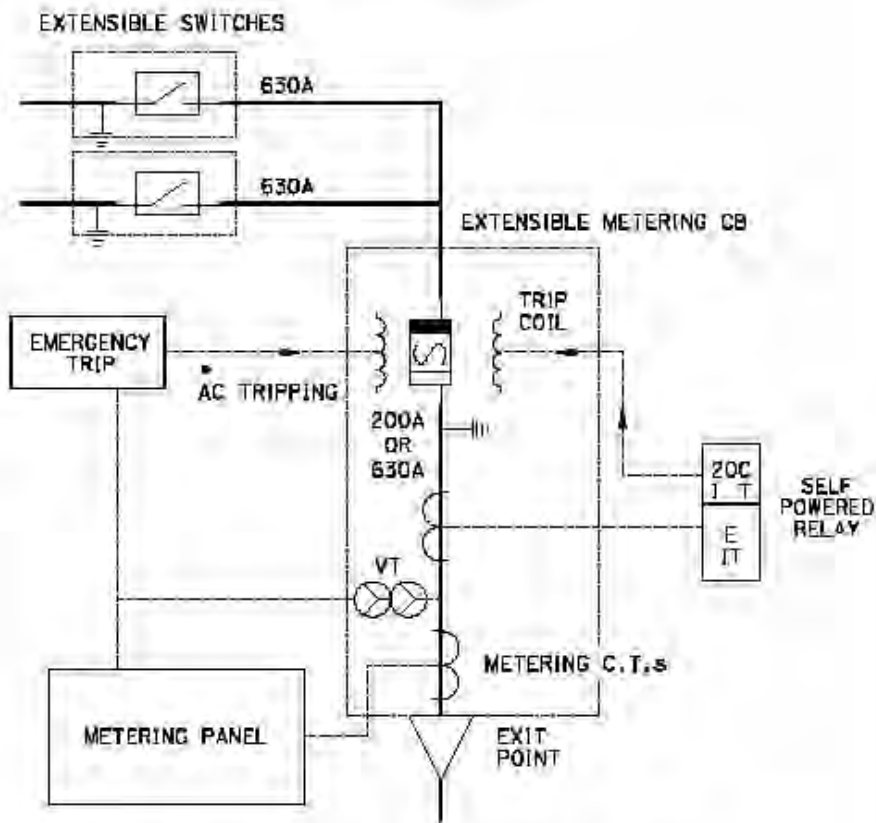

6.6kV LOAD MVA	11kV LOAD MVA	METERING CT RATIO (A) CLASS 0.5a	PROTECTION CT RATIO
100 - 570	100 - 950	100/50/5	200/1
570 - 1100	950 - 1900	100/50/5	200/1
1100 - 2200	1900 - 3800	400/200/5	800/1
2200 - 4500	3800 - 7600	400/200/5	800/1

* AC TRIPPING SUPPLY IS DERIVED FROM METERING VT

11	RJB		7/00	TEXT MODIFIED	
Rev No	Drawn	Chk'd	App'd	Date	Revision
ORIGINAL ISSUE	DATE	WESTERN POWER DISTRIBUTION Design Department Avonbank, Pender Road, Bristol BS2 0TH Tel: 0117 933 2000 Fax: 0117 933 2001			
Drawn	RJB	7/90	Title	Drg. No.	
Checked			EXTENSIBLE RING MAIN UNIT	06/69/2892/2	
Approved				Rev No	
SCALE	N.T.S.				11

ALL RIGHTS ARE RESERVED TO SIME (UK). NO PART OF THIS DRAWING MAY BE REPRODUCED OR TRANSMITTED IN ANY FORM OR BY ANY MEANS, INCLUDING PHOTOCOPYING AND RECORDING, OR STORED IN A RETRIEVAL SYSTEM OF ANY NATURE, WITHOUT PERMISSION.

ARRANGEMENT No 3

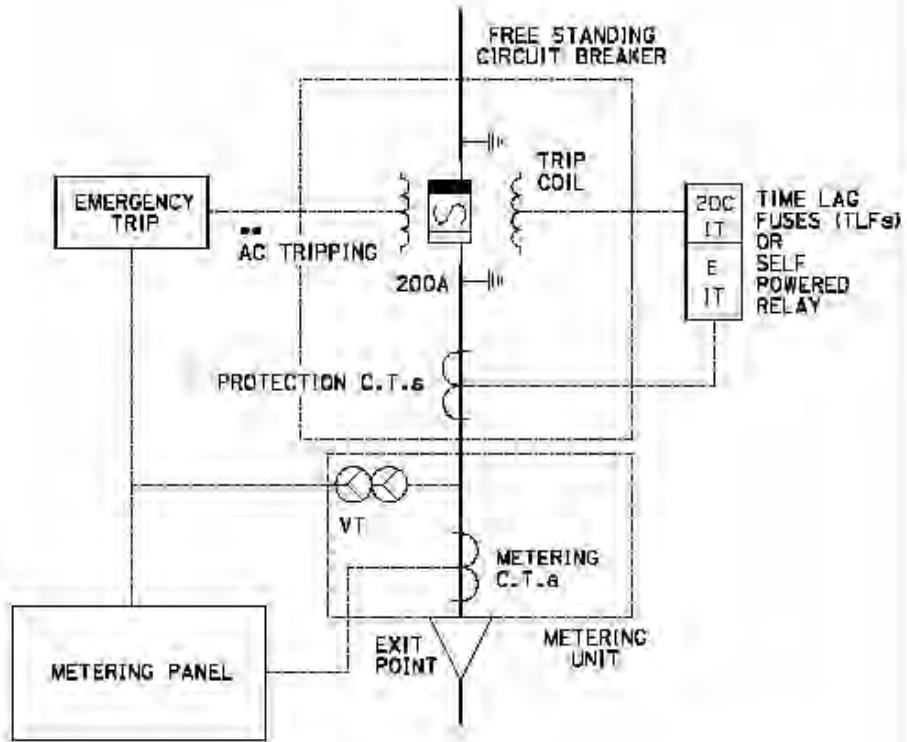

6.6kV LOAD KVA	11kV LOAD KVA	METERING CT RATIO (A) CLASS 0.5B	PROTECTION CT RATIO	PROTECTION TYPE
100 - 570	100 - 950	100/50/5	100/50/5	TLF
570 - 1100*	950 - 1900*	100/50/5	100/50/5	TLF
1100 - 2200	1900 - 3800	200/100/5	200/1	SELF POWERED RELAY

* SEE SECTION 3 FOR TRANSFORMER PROTECTION RESTRICTIONS

** AC TRIPPING SUPPLY IS DERIVED FROM THE METERING VT

5	RJB			7/00	TEXT CHANGED
Rev No	Drawn	Chk'd	App'd	Date	Revision
ORIGINAL ISSUE	DATE	WESTERN POWER DISTRIBUTION Design Department Avonbank Feeder Road, Bristol BS2 0TB Tel: 0117 959 2000 Fax: 0117 959 2001.			WESTERN POWER DISTRIBUTION
Drawn	RJB	7/98	Title		
Checked			FREE STANDING CIRCUIT BREAKER		Drq. No.
Approved					Rev No
SCALE	N.T.S.				06/69/2891/3
					5

ALL RIGHTS ARE RESERVED TO SWE plc. NO PART OF THIS DRAWING MAY BE REPRODUCED OR TRANSMITTED IN ANY FORM OR BY ANY MEANS, INCLUDING PHOTOCOPYING AND RECORDING, OR STORED IN A RETRIEVAL SYSTEM OF ANY NATURE, WITHOUT PERMISSION.

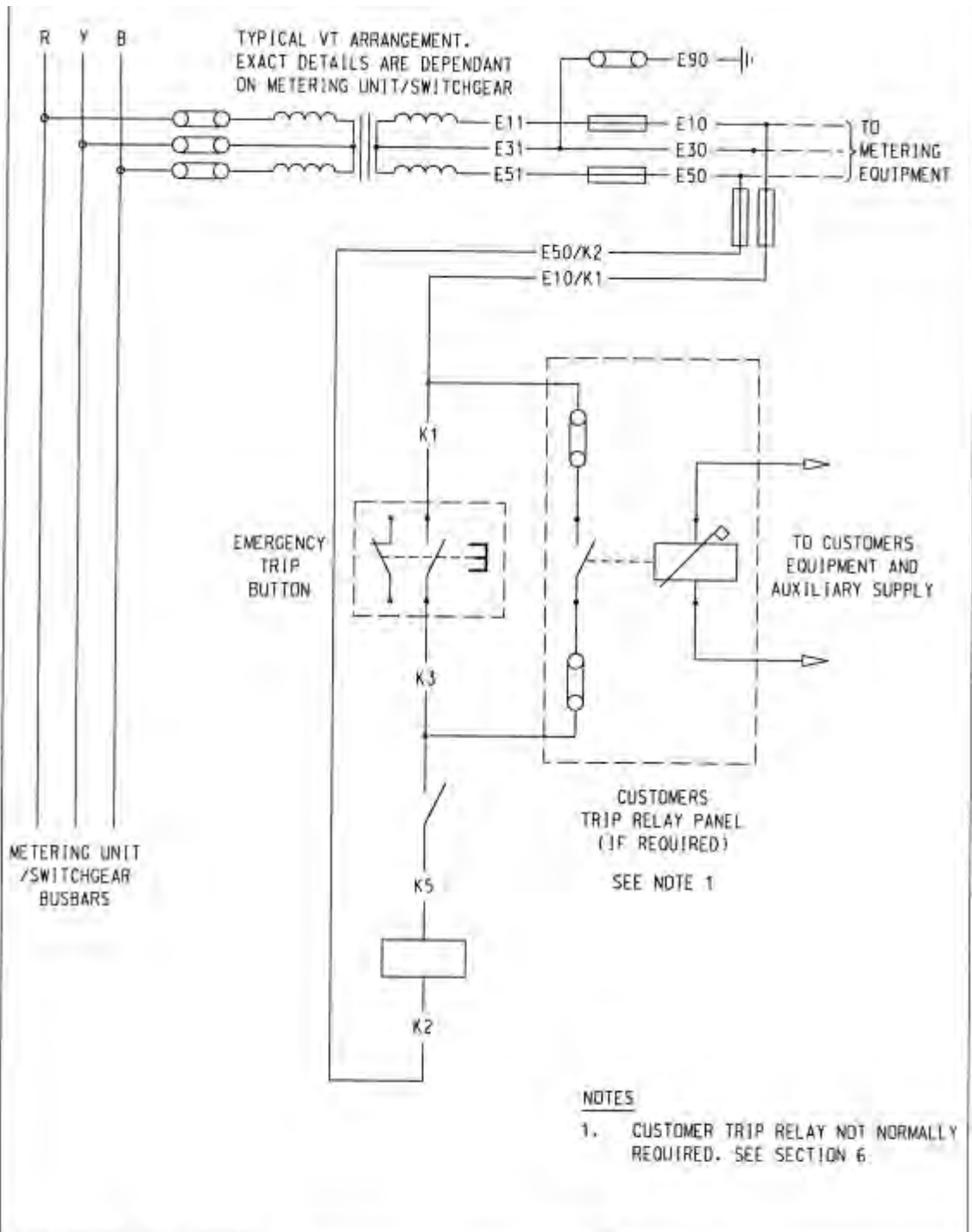

ORIGINAL ISSUE	Date	WESTERN POWER DISTRIBUTION	Title STANDARD SMPC SCHEMATICS SCHEMATIC DIAGRAM OF AC EMERGENCY TRIPPING	Drg.No SMPC 658
Drawn	CM 27/10/99			
Checked				
Approved				
SCALE				

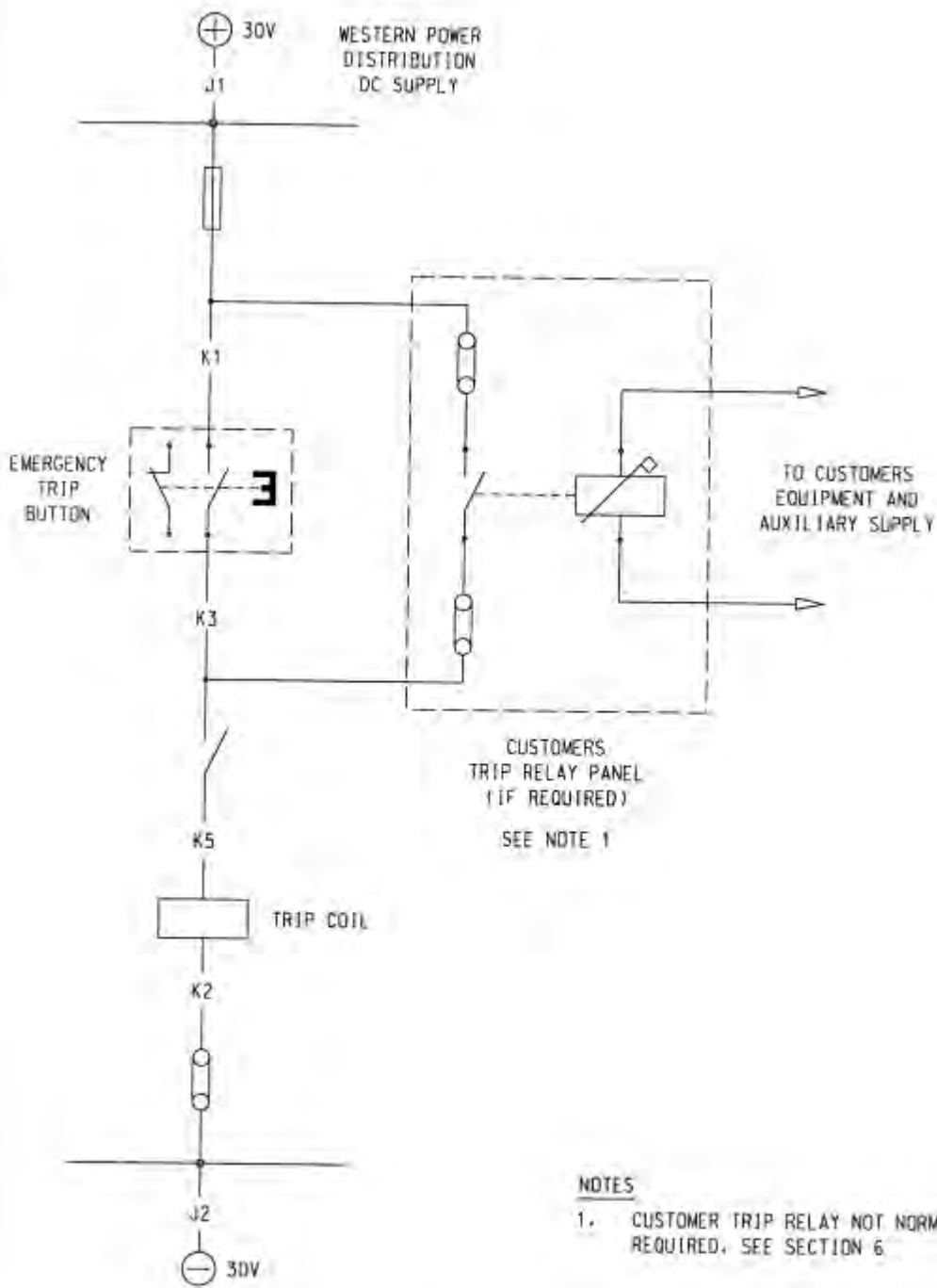

ORIGINAL ISSUE	Date	WESTERN POWER DISTRIBUTION	Title	Org.No
Drawn	CM 25/10/99			
Checked		STANDARD SMPC SCHEMATICS	SCHEMATIC DIAGRAM OF DC EMERGENCY TRIPPING	SMPC 657
Approved				
SCALE				

STANDARD LV ARRANGEMENTS

INDEX

- (1) INTRODUCTION**
- (2) STANDARD ARRANGEMENTS**
- (3) CABLES**
- (4) CIRCUIT BREAKERS**
- (5) EARTHING**
- (6) GENERATION**
- (7) METERING**
- (8) MULTIPLE CONNECTIONS TO A SINGLE CUSTOMER**

APPENDICES

- A ARMOURED SOLIDAL CABLE CONFIGURATIONS & RATINGS**
- B EARTHING AND SOLIDAL BONDING REQUIREMENTS FOR ARRANGEMENTS 3 AND 4**
- D SUPPLEMENTARY INSULATION FOR SOLIDAL ARMOURING**
- E METERING CIRCUIT BREAKER DRAWINGS**

1.0 INTRODUCTION

This document specifies four standard arrangements for commercial and industrial loads between 69kVA and 1000kVA connected at low voltage (LV).

Current ratings are calculated using a the nominal 230V as follows:

$$LoadCurrent(A) = \frac{Load(kVA)}{230 * 3} * 1000$$

2.0 STANDARD ARRANGEMENTS

The four standard arrangements are shown in Figures 1 to 4 and maximum cable lengths specified in Tables 1 to 4. A summary of the application of the four arrangements is provided in Table 5.

Maximum cable lengths have been selected to ensure:

- Acceptable voltage drop along the LV cable.
- LV cable is adequately protected.
- Protection clearance time at the customer's incoming equipment is less than 5s

The voltage drop calculations assume that only one connection is made to the LV cable. Further information is provided in Section 9.0.

2.1 Arrangement 1

Arrangement 1 is suitable for connecting 3 phase loads between 69kVA and 259kVA (and up to 300kVA where Winter cable ratings can be utilised). The LV connection is derived from a conventional 3 phase Wavecon cable connected to a standard transformer fuse way.

The max LV fuse size that grades with the transformer HV protection is specified in ST:TP4B/2. It is acceptable for this fuse size to be exceeded where the transformer is dedicated to one customer.

2.2 Arrangement 2

Arrangement 2 can be used where it is necessary to exceed the maximum cut-out fuse size that grades with the transformer HV protection and where more than one customer is connected to the transformer.

An MCCB is installed in the transformer cabinet and settings applied that grade as far as possible with the transformer protection. Additional customers are connected to other fuse-ways.

2.3 Arrangement 3

Arrangement 3 is used for large LV connections up to 1449A where the LV cable is in excess of 20m.

An MCCB is installed within the transformer LV cabinet and at the intake position. Both these MCCBs are owned and operated by WPD. 600mm² or 740mm² armoured solidal cables are laid between the two MCCBs. The number (4, 7 or 11) of solidals will depend on the customer's load, the laying configuration (trefoil or flat) and the medium in which the cables are laid (direct in ground, in ducts or in air).

The size and number of solidals specified in Table 3 assume they are laid direct in ground in a trefoil configuration. Where alternative conditions apply the ratings shall be checked against the values in Table A1 (Appendix A).

2.4 Arrangement 4

Arrangement 4 is similar to arrangement 3 but is applicable to short lengths of solidals (less than 20m).

The solidals are connected directly to the transformer, via a cable box. An MCCB is installed at the intake position owned and operated by WPD.

The size and number of solidals specified in Table 3 assume they are laid direct in ground in a trefoil configuration. Where alternative conditions apply the ratings shall be checked against the values in Table A1 (Appendix A).

2.5 Connections to Metering MCCB

When arrangements 3 or 4 are utilised, the customer can connect to the metering MCCB either via a direct busbar connection or via cables. The maximum length of cable, between WPD's MCCB and the customer's incoming switchgear shall be 10m.

ARRANGEMENT 1

Conventionally Fused

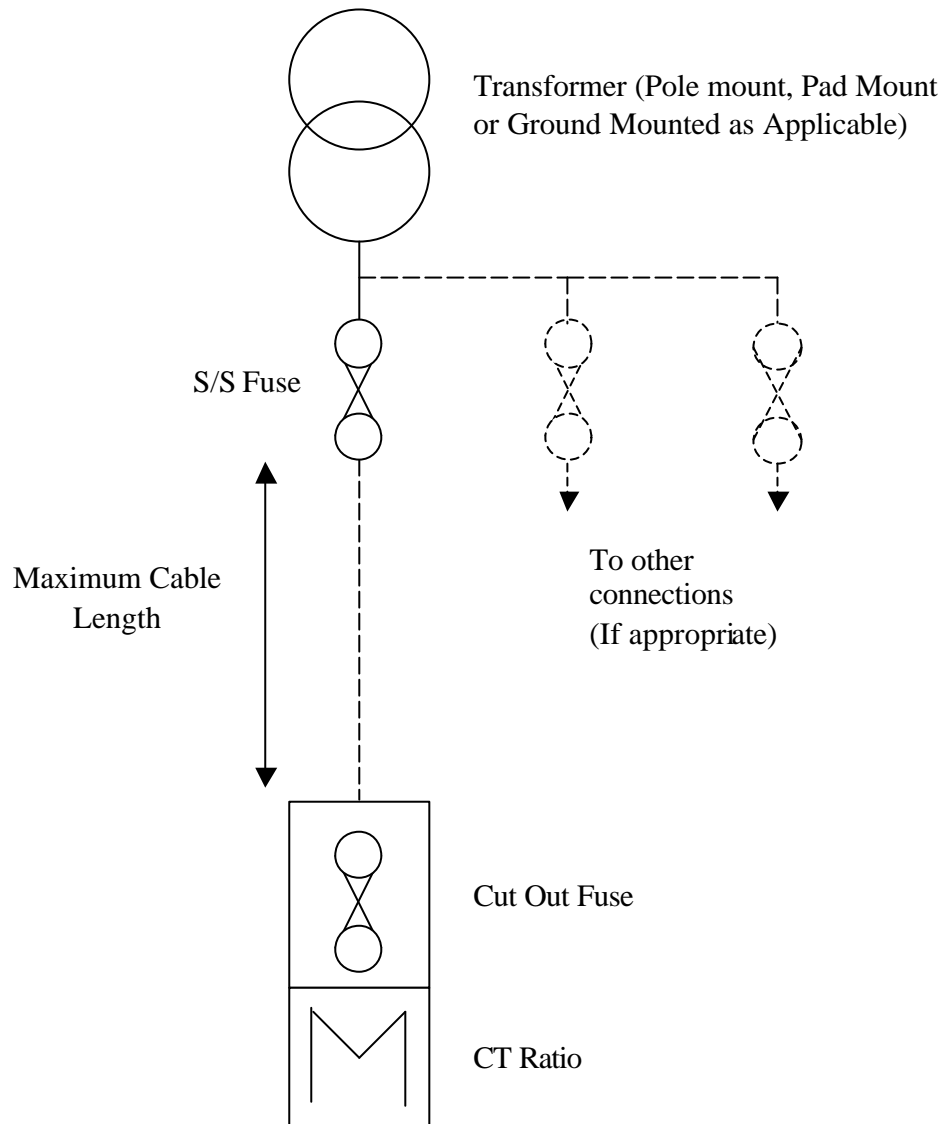

FIGURE 1

Table 1 Cable Requirements For Arrangement 1

Transformer Size(kVA)	Load	LV Cabinet Fuse (Amps)	Cut-Out Fuse (Amps)	Max. Cable Length (m)		
				95 Wcon	185 Wcon	300 Wcon
100	69kVA (100A)	200	100	322	584	854
	100kVA (144A)	200	160	224	406	587
200	69kVA (100A)	200	100	322	584	854
	100kVA (100A)	200	160	224	406	587
	134kVA (195A)	200	200	165	300	433
	172kVA (250A)	250 ^[1]	250 ^[1]	-	234	338
	198kVA (287A)	315 ^[1]	315 ^[1]	-	204	294
315	69kVA (100A)	315	100	297	555	675
	100kVA (144A)	315	160	224	406	587
	134kVA (195A)	315	200	165	300	433
	172kVA (250A)	315	250	-	234	338
	217kVA (315A)	315	315	-	185	268
	259kVA (376A)	400 ^[1]	400 ^[1]	-	-	225
	300kVA (434A)	500 ^[1]	500 ^[1]	-	-	195 ^[2]
500	69kVA (100A)	400	100	219	409	498
	100kVA (144A)	400	160	219	406	498
	134kVA (195A)	400	200	165	300	433
	172kVA (250A)	400	250	-	234	338
	200kVA (289A)	400	315	-	202	292
	225kVA (326A)	400	355	-	-	259
	259kVA (376A)	400	400	-	-	225
	300kVA (434A)	500 ^[1]	500 ^[1]	-	-	195 ^[2]
800	69kVA (100A)	400	100	221	415	506
	100kVA (144A)	400	160	221	406	506
	134kVA (195A)	400	200	165	300	433
	172kVA (250A)	400	250	-	234	338
	200kVA (289A)	400	315	-	202	292
	225kVA (326A)	400	355	-	-	259
	259kVA (376A)	400	400	-	-	225
	300kVA (434A)	500	500	-	-	195 ^[2]
1000	69kVA (100A)	400	100	222	417	508
	100kVA (144A)	400	160	222	406	508
	134kVA (195A)	400	200	165	300	433
	172kVA (250A)	400	250	129	234	338
	200kVA (289A)	400	315	-	202	292
	225kVA (326A)	400	355	-	-	259
	259kVA (376A)	400	400	-	-	225
	300kVA (434A)	500	500	-	-	195 ^[2]

Note 1 LV fuse does not grade with HV transformer protection (See ST:TP4B/2). Only use this arrangement when transformer is dedicated to 1 customer.

Note 2 This arrangement is only acceptable if Winter cable rating can be utilised (see ST:SD8B as amended)

ARRANGEMENT 2

MCCB to Heavy Duty Cut-out

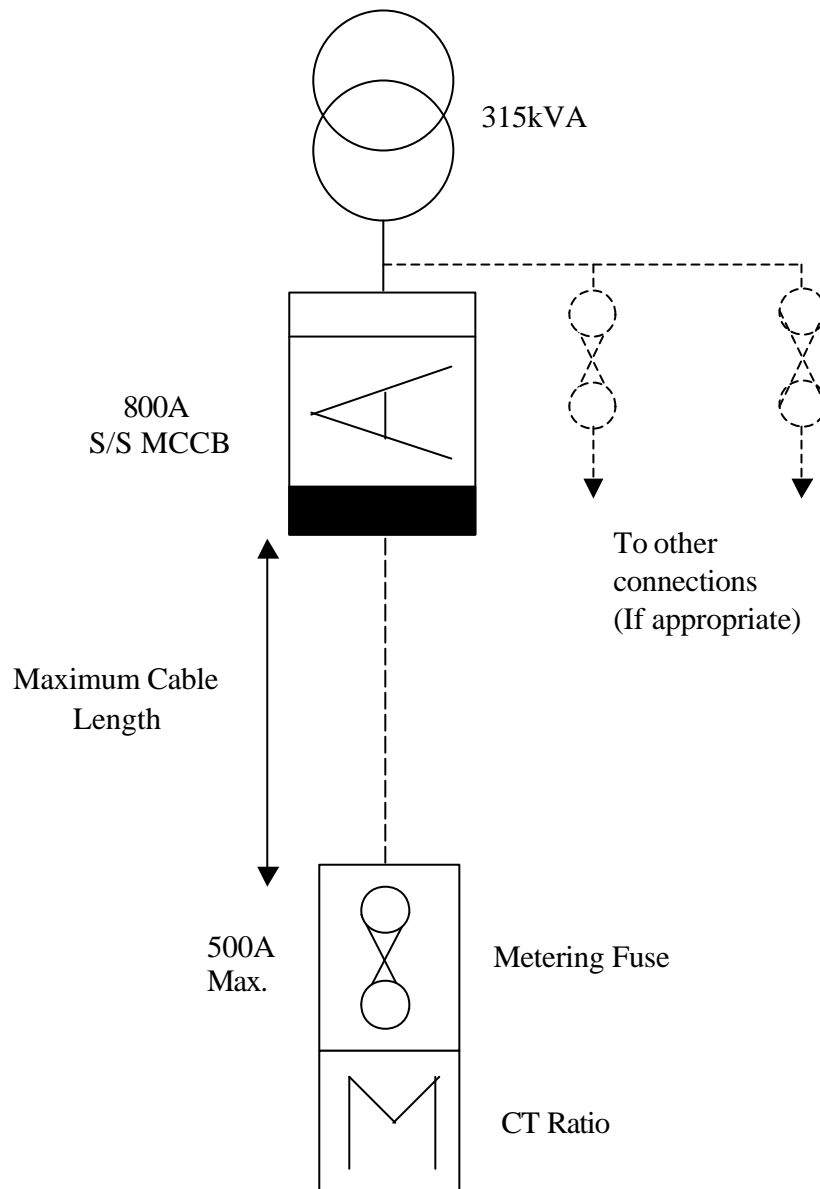

FIGURE 2

Table 2 Cable Requirements For Arrangement 2

Transformer Size (kVA)	Load	Cut-out Fuse Size (A)	MCCB Trip Unit Settings ^[1] (800A MCCB)	Maximum Cable Length (m)	
				185Wcon	300Wcon
315	172kVA (250A)	250	$I_n = 800A$ $I_r = 320A (0.4xI_n)$ $t_r = 2s (at 6xI_r)$ $I_{sd} = 1600A (5xI_r)$ $t_{sd} = 0.1s, I^2t off$ $I_f = 3200A (4xI_n)$	234	338
	198kVA (287A)	315	$I_n = 800A$ $I_r = 320A (0.4xI_n)$ $t_r = 2s (at 6xI_r)$ $I_{sd} = 1600A (5xI_r)$ $t_{sd} = 0.1s, I^2t off$ $I_f = 3200A (4xI_n)$	204	294
	230kVA (333A)	355	$I_n = 800A$ $I_r = 400A (0.5xI_n)$ $t_r = 2s (at 6x I_r)$ $I_{sd} = 1600A (4xI_r)$ $t_{sd} = 0.1s, I^2t off$ $I_f = 3200A (4xI_n)$	-	254
	259kVA (376A)	400	$I_n = 800A$ $I_r = 400A (0.5xI_n)$ $t_r = 2s (at 6x I_r)$ $I_{sd} = 1600A (4xI_r)$ $t_{sd} = 0.1s, I^2t off$ $I_f = 3200A (4xI_n)$	-	225
	300kVA (434A)	500	$I_n = 800A$ $I_r = 480A (0.6xI_n)$ $t_r = 2s (at 6x I_r)$ $I_{sd} = 1920A (4xI_r)$ $t_{sd} = 0.1s, I^2t off$ $I_f = 3200A (4xI_n)$	-	195 ^[2]
500kVA	230kVA (333A)	355	$I_n = 800A$ $I_r = 400A (0.5xI_n)$ $t_r = 2s (at 6x I_r)$ $I_{sd} = 1600A (4xI_r)$ $t_{sd} = 0.1s, I^2t off$ $I_f = 3200A (4xI_n)$	-	254
	259kVA (376A)	400	$I_n = 800A$ $I_r = 400A (0.5xI_n)$ $t_r = 2s (at 6x I_r)$ $I_{sd} = 1600A (4xI_r)$ $t_{sd} = 0.1s, I^2t off$ $I_f = 3200A (4xI_n)$	-	225
	300kVA (434A)	500	$I_n = 800A$ $I_r = 480A (0.6xI_n)$ $t_r = 2s (at 6x I_r)$ $I_{sd} = 1920A (4xI_r)$ $t_{sd} = 0.1s, I^2t off$ $I_f = 3200A (4xI_n)$	-	195 ^[2]

Note 1 MCCB settings are designed to grade with transformer HV protection but not with cut-out fuses.

Note 2 This arrangement is only suitable if Winter cable rating can be utilised (see ST:SD8B as amended)

ARRANGEMENT 3

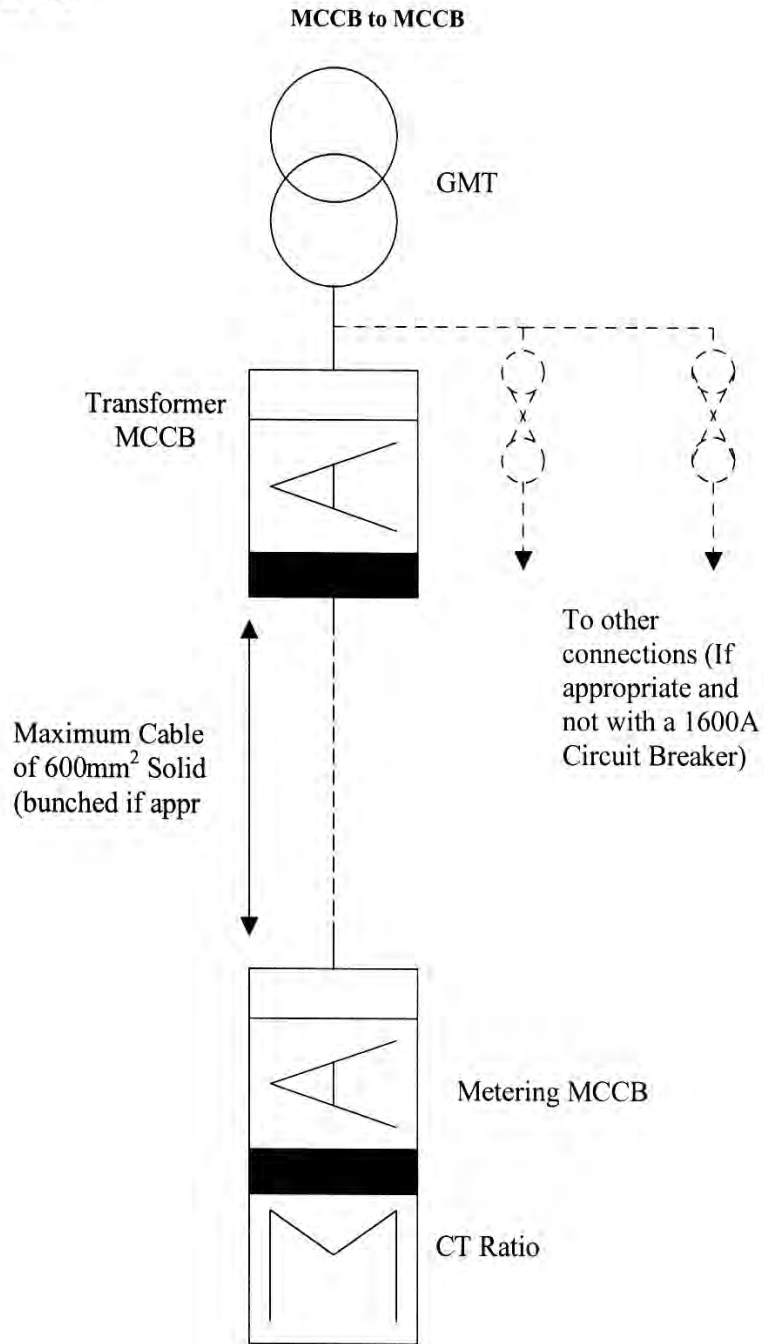

FIGURE 3

Table 3 Cable Requirements For Arrangement 3

Transformer Size (kVA)	Load	T/F Mounted MCCB Trip Unit Settings	Metering MCCB Trip Unit Settings	Metering CT ratio	Maximum Circuit Length (m)					
					4 x 600 solidals	4 x 740 solidals	7 x 600 solidals	7 x 740 solidals	11 x 600 solidals	11 x 740 solidals
500	200kVA (289A)	Rating (I_n) = 800A I _r = 400A (0.5xI _n) t _r = 8s (at 6x I _r) I _{sd} = 2400A (6x I _r) t _{sd} = 0.1s, I ² t off I _i = 6400A (8x I _n)	Rating (I_n) = 800A I _r = 320A (0.4xI _n) t _r = 4s (at 6x I _r) I _{sd} = 1600A (5x I _r) t _{sd} = 0s, I ² t off I _i = 4800A (6x I _n)	800/5	150	150	150	150	-	-
500	300kVA (434A)	Rating (I_n) = 800A I _r = 560A (0.7xI _n) t _r = 8s (at 6x I _r) I _{sd} = 2240A (4x I _r) t _{sd} = 0.1s, I ² t off I _i = 6400A (8x I _n)	Rating (I_n) = 800A I _r = 480A (0.6xI _n) t _r = 4s (at 6x I _r) I _{sd} = 1440A (3x I _r) t _{sd} = 0s, I ² t off I _i = 4800A (6x I _n)	800/5	150	150	150	150	-	-
500	400kVA (580A)	Rating (I_n) = 800A I _r = 760A (0.95xI _n) t _r = 4s (at 6x I _r) I _{sd} = 2280A (3x I _r) t _{sd} = 0.1s, I ² t off I _i = 6400A (8x I _n)	Rating (I_n) = 800A I _r = 640A (0.8xI _n) t _r = 2s (at 6x I _r) I _{sd} = 1600A (2.5xI _r) t _{sd} = 0s, I ² t off I _i = 4800A (6x I _n)	800/5	150	150	150	150	-	-
500	500kVA (724A)	Rating (I_n) = 1250A I _r = 875A (0.7xI _n) t _r = 4s (at 6x I _r) I _{sd} = 2625A (3x I _r) t _{sd} = 0.1s, I ² t off I _i = 5000A (4x I _n)	Rating (I_n) = 800A I _r = 760A (0.95xI _n) t _r = 2s (at 6x I _r) I _{sd} = 1900A (2.5x I _r) t _{sd} = 0s, I ² t off I _i = 3200A (4x I _n)	800/5	-	145	150	150	-	-
800	200kVA (289A)	Rating (I_n) = 800A I _r = 400A (0.5xI _n) t _r = 8s (at 6x I _r) I _{sd} = 3200A (6x I _r) t _{sd} = 0.1s, I ² t off I _i = 6400A (8x I _n)	Rating (I_n) = 800A I _r = 320A (0.4xI _n) t _r = 4s (at 6x I _r) I _{sd} = 1920A (6x I _r) t _{sd} = 0s, I ² t off I _i = 4800A (6x I _n)	800/5	150	150	150	150	-	-

Table 3 Cable Requirements For Arrangement 3

Transformer Size (kVA)	Load	T/F Mounted MCCB Trip Unit Settings	Metering MCCB Trip Unit Settings	Metering CT ratio	Maximum Circuit Length (m)					
					4 x 600 solidals	4 x 740 solidals	7 x 600 solidals	7 x 740 solidals	11 x 600 solidals	11 x 740 solidals
800	300kVA (434A)	Rating (I_n) = 800A I _r = 560A (0.7xI _n) t _r = 8s (at 6x I _r) I _{sd} = 2800A (5x I _r) t _{sd} = 0.1s, I ² t off I _j = 6400A (8x I _n)	Rating (I_n) = 800A I _r = 480A (0.6xI _n) t _r = 4s (at 6x I _r) I _{sd} = 1920A (4x I _r) t _{sd} = 0s, I ² t off I _j = 4800A (6x I _n)	800/5	150	150	150	150	-	-
800	400kVA (580A)	Rating (I_n) = 800A I _r = 760A (0.95xI _n) t _r = 4s (at 6x I _r) I _{sd} = 3040A (4x I _r) t _{sd} = 0.1s, I ² t off I _j = 6400A (8x I _n)	Rating (I_n) = 800A I _r = 640A (0.8xI _n) t _r = 2s (at 6x I _r) I _{sd} = 1920A (3xI _r) t _{sd} = 0s, I ² t off I _j = 4800A (6x I _n)	800/5	150	150	150	150	-	-
800	500kVA (724A)	Rating (I_n) = 1250A I _r = 875A (0.7xI _n) t _r = 4s (at 6x I _r) I _{sd} = 2625A (3x I _r) t _{sd} = 0.1s, I ² t off I _j = 5000A (4x I _n)	Rating (I_n) = 800A I _r = 760A (0.95xI _n) t _r = 2s (at 6xI _r) I _{sd} = 1900A (2.5xI _r) t _{sd} = 0s, I ² t off I _j = 3200A (4x I _n)	800/5	-	145	150	150	-	-
800	600kVA (869A)	Rating (I_n) = 1250A I _r = 1000A (0.8xI _n) t _r = 2s (at 6x I _r) I _{sd} = 3000A (3xI _r) t _{sd} = 0.1s, I ² t off I _j = 5000A (4x I _n)	Rating (I_n) = 1250A I _r = 875A (0.7xI _n) t _r = 1s (at 6x I _r) I _{sd} = 2187.5A (2.5xI _r) t _{sd} = 0s, I ² t off I _j = 3750A (3x I _n)	800/5	-	-	150	150	-	-
800	700kVA (1014A)	Rating (I_n) = 1250A I _r = 1250A (1.0xI _n) t _r = 2s (at 6x I _r) I _{sd} = 3125A (2.5xI _r) t _{sd} = 0.1s, I ² t off I _j = 5000A (4x I _n)	Rating (I_n) = 1250A I _r = 1125A (0.9xI _n) t _r = 1s (at 6x I _r) I _{sd} = 2250A (2xI _r) t _{sd} = 0s, I ² t off I _j = 3750A (3x I _n)	800/5	-	-	150	150	-	-

Table 3 Cable Requirements For Arrangement 3

Transformer Size (kVA)	Load	T/F Mounted MCCB Trip Unit Settings	Metering MCCB Trip Unit Settings	Metering CT ratio	Maximum Circuit Length (m)					
					4 x 600 solidals	4 x 740 solidals	7 x 600 solidals	7 x 740 solidals	11 x 600 solidals	11 x 740 solidals
800	800kVA (1159A)	Rating (I_n) = 1250A I _r = 1250A (1.0xI _n) t _r = 2s (at 6x I _r) I _{sd} = 3125A (2.5xI _r) t _{sd} = 0.1s, I ² t off I _i = 5000A (4x I _n)	Rating (I_n) = 1250A I _r = 1187A (0.95xI _n) t _r = 1s (at 6x I _r) I _{sd} = 2375A (2xI _r) t _{sd} = 0s, I ² t off I _i = 3750A (3x I _n)	1200/5	-	-	150	150	-	-
1000	200kVA (289A)	Rating (I_n) = 800A I _r = 400A (0.5xI _n) t _r = 8s (at 6x I _r) I _{sd} = 3200A (8x I _r) t _{sd} = 0.1s, I ² t off I _i = 8000A (10x I _n)	Rating (I_n) = 800A I _r = 320A (0.4xI _n) t _r = 4s (at 6x I _r) I _{sd} = 1920A (6x I _r) t _{sd} = 0s, I ² t off I _i = 6400A (8x I _n)	800/5	150	150	150	150	-	-
1000	300kVA (434A)	Rating (I_n) = 800A I _r = 560A (0.7xI _n) t _r = 8s (at 6x I _r) I _{sd} = 3360A (6xI _r) t _{sd} = 0.1s, I ² t off I _i = 8000A (10xI _n)	Rating (I_n) = 800A I _r = 480A (0.6xI _n) t _r = 4s (at 6x I _r) I _{sd} = 2400A (5xI _r) t _{sd} = 0s, I ² t off I _i = 6400A (8xI _n)	800/5	150	150	150	150	-	-
1000	400kVA (580A)	Rating (I_n) = 800A I _r = 760A (0.95xI _n) t _r = 4s (at 6x I _r) I _{sd} = 3800A (5xI _r) t _{sd} = 0.1s, I ² t off I _i = 8000A (10x I _n)	Rating (I_n) = 800A I _r = 640A (0.8xI _n) t _r = 2s (at 6x I _r) I _{sd} = 2560A (4x I _r) t _{sd} = 0s, I ² t off I _i = 6400A (8xI _n)	800/5	150	150	150	150	-	-
1000	500kVA (724A)	Rating (I_n) = 1250A I _r = 875A (0.7xI _n) t _r = 4s (at 6x I _r) I _{sd} = 3500A (4x I _r) t _{sd} = 0.1s, I ² t off I _i = 7500A (6x I _n)	Rating (I_n) = 800A I _r = 760A (0.95xI _n) t _r = 2s (at 6x I _r) I _{sd} = 2280A (3x I _r) t _{sd} = 0s, I ² t off I _i = 4800A (8xI _n)	800/5		145	150	150	-	-

Table 3 Cable Requirements For Arrangement 3

Transformer Size (kVA)	Load	T/F Mounted MCCB Trip Unit Settings	Metering MCCB Trip Unit Settings	Metering CT ratio	Maximum Circuit Length (m)					
					4 x 600 solidals	4 x 740 solidals	7 x 600 solidals	7 x 740 solidals	11 x 600 solidals	11 x 740 solidals
1000	600kVA (869A)	Rating (I_n) = 1250A I _r = 1000A (0.8xI _n) t _r = 2s (at 6x I _p) I _{sd} = 3000A (3xI _r) t _{sd} = 0.1s, I ² t off I _i = 7500A (6x I _n)	Rating (I_n) = 1250A I _r = 875A (0.7xI _n) t _r = 2s (at 6xI _r) I _{sd} = 2187.5A (2.5xI _r) t _{sd} = 0s, I ² t off I _i = 5000A (4xI _n)	800/5	-	-	150	150	-	-
1000	700kVA (1014A)	Rating (I_n) = 1250A I _r = 1250A (1.0xI _n) t _r = 2s (at 6x I _p) I _{sd} = 3750A (3xI _r) t _{sd} = 0.1s, I ² t off I _i = 7500A (6x I _n)	Rating (I_n) = 1250A I _r = 1125A (0.9xI _n) t _r = 1s (at 6x I _p) I _{sd} = 2812.5A (2.5xI _r) t _{sd} = 0s, I ² t off I _i = 5000A (4xI _n)	800/5	-	-	150	150	-	-
1000	800kVA (1159A)	Rating (I_n) = 1600A I _r = 1440A (0.9xI _n) t _r = 2s (at 6x I _p) I _{sd} = 3600A (2.5 xI _r) t _{sd} = 0.1s, I ² t off I _i = 6400A (4xI _n) I _g = 1200A (setting J) t _g = 0.4s, I ² t on	Rating (I_n) = 1250A I _r = 1187.5A (0.95xI _n) t _r = 1s (at 6x I _p) I _{sd} = 2375A (2xI _r) t _{sd} = 0s, I ² t off I _i = 5000A (4xI _n)	1200/5	-	-	150	150	-	-

Table 3 Cable Requirements For Arrangement 3

Transformer Size (kVA)	Load	T/F Mounted MCCB Trip Unit Settings	Metering MCCB Trip Unit Settings	Metering CT ratio	Maximum Circuit Length (m)					
					4 x 600 solidals	4 x 740 solidals	7 x 600 solidals	7 x 740 solidals	11 x 600 solidals	11 x 740 solidals
1000	900kVA (1304A)	Rating (I_n) = 1600A $I_r = 1600A (1.0xI_n)$ $t_r = 2s (at 6x I_r)$ $I_{sd} = 4000A (2.5xI_r)$ $t_{sd} = 0.1s, I^2t \text{ off}$ $I_i = 6400A (4xI_n)$ $I_g = 1200A (setting J)$ $t_g = 0.4s, I^2t \text{ on}$	Rating (I_n) = 1600A $I_r = 1440A (0.9xI_n)$ $t_r = 1s (at 6x I_r)$ $I_{sd} = 2880A (2xI_r)$ $t_{sd} = 0s, I^2t \text{ off}$ $I_i = 4800A (3xI_n)$ $I_g = 1200A (setting J)$ $t_g = 0.3s, I^2t \text{ on}$	1200/5	-	-	-	-	150	150
1000	1000kVA (1449A)	Rating (I_n) = 1600A $I_r = 1600A (1.0xI_n)$ $t_r = 2s (at 6x I_r)$ $I_{sd} = 4000A (2.5xI_r)$ $t_{sd} = 0.1s, I^2t \text{ off}$ $I_i = 6400A (4xI_n)$ $I_g = 1200A (setting J)$ $t_g = 0.4s, I^2t \text{ on}$	Rating (I_n) = 1600A $I_r = 1520A (0.95xI_n)$ $t_r = 1s (at 6x I_r)$ $I_{sd} = 3040A (2xI_r)$ $t_{sd} = 0s, I^2t \text{ off}$ $I_i = 4800A (3xI_n)$ $I_g = 1200A (setting D)$ $t_g = 0.3s, I^2t \text{ on}$	1200/5	-	-	-	-	150	150

ARRANGEMENT 4

No Transformer Mounted LV Cabinet

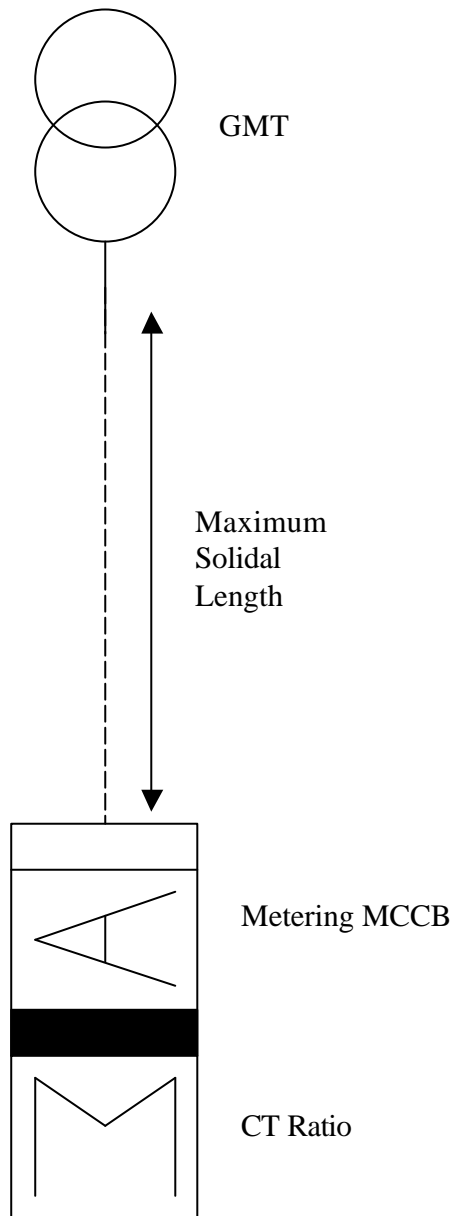

FIGURE 4

Table 4 Cable Requirements For Arrangement 4

Transformer Size (kVA)	Load (Amps)	Metering MCCB Trip Unit Settings	Metering CT Ratio	Maximum Circuit Length (m)				
				4 x 600 solidals	4 x 740 solidals	7 x 600 solidals	7 x 740 solidals	11 x 740 solidals
315	200kVA (456A)	Rating (I_n) = 800A I _r = 320A (0.4xI _n) t _r = 2s (at 6xI _r) I _{sd} = 1600A (5xI _r) t _{sd} = 0.1s, I ² t off I _i = 3200A (4xI _n)	800/5	20	20	20	20	-
315	315kVA (456A)	Rating (I_n) = 800A I _r = 480A (0.6xI _n) t _r = 2s (at 6xI _r) I _{sd} = 1440A (3xI _r) t _{sd} = 0.1s, I ² t off I _i = 3200A (4xI _n)	800/5	20	20	20	20	-
500	200kVA (289A)	Rating (I_n) = 800A I _r = 320A (0.4xI _n) t _r = 2s (at 6xI _r) I _{sd} = 2560A (8xI _r) t _{sd} = 0.1s, I ² t off I _i = 4800A (6xI _n)	800/5	20	20	20	20	-
500	300kVA (434A)	Rating (I_n) = 800A I _r = 480A (0.6xI _n) t _r = 2s (at 6xI _r) I _{sd} = 2400A (5xI _r) t _{sd} = 0.1s, I ² t off I _i = 4800A (6xI _n)	800/5	20	20	20	20	-
500	400kVA (579A)	Rating (I_n) = 800A I _r = 640A (0.8xI _n) t _r = 2s (at 6xI _r) I _{sd} = 2560A (4xI _r) t _{sd} = 0.1s, I ² t off I _i = 4800A (6xI _n)	800/5	20	20	20	20	-

Table 4 Cable Requirements For Arrangement 4

Transformer Size (kVA)	Load (Amps)	Metering MCCB Trip Unit Settings	Metering CT Ratio	Maximum Circuit Length (m)				
				4 x 600 solidals	4 x 740 solidals	7 x 600 solidals	7 x 740 solidals	11 x 740 solidals
500	500kVA (724A)	Rating (I_n) = 800A I _r = 760A (0.95xI _n) t _r = 2s (at 6xI _r) I _{sd} = 2280A (3xI _r) t _{sd} = 0.1s, I ² t off I _i = 4800A (6xI _n)	800/5		20	20	20	-
800	200kVA (289A)	Rating (I_n) = 800A I _r = 320A (0.4xI _n) t _r = 2s (at 6xI _r) I _{sd} = 2560A (8xI _r) t _{sd} = 0.1s, I ² t off I _i = 6400A (8xI _n)	800/5	20	20	20	20	-
800	300kVA (434A)	Rating (I_n) = 800A I _r = 480A (0.6xI _n) t _r = 2s (at 6xI _r) I _{sd} = 2400A (5xI _r) t _{sd} = 0.1s, I ² t off I _i = 6400A (8xI _n)	800/5	20	20	20	20	-
800	400kVA (579A)	Rating (I_n) = 800A I _r = 640A (0.8xI _n) t _r = 2s (at 6xI _r) I _{sd} = 2560A (4xI _r) t _{sd} = 0.1s, I ² t off I _i = 6400A (8xI _n)	800/5	20	20	20	20	-
800	500kVA (724A)	Rating (I_n) = 800A I _r = 760A (0.95xI _n) t _r = 2s (at 6xI _r) I _{sd} = 2280A (3xI _r) t _{sd} = 0.1s, I ² t off I _i = 6400A (8xI _n)	800/5	-	20	20	20	-

Table 4 Cable Requirements For Arrangement 4

Transformer Size (kVA)	Load (Amps)	Metering MCCB Trip Unit Settings	Metering CT Ratio	Maximum Circuit Length (m)				
				4 x 600 solidals	4 x 740 solidals	7 x 600 solidals	7 x 740 solidals	11 x 740 solidals
800	600kVA (869A)	Rating (I_n) = 1250A I _r = 875A (0.7xI _n) t _r = 2s (at 6xI _r) I _{sd} = 2625A (3xI _r) t _{sd} = 0.1s, I ² t off I _i = 5000A (4xI _n)	1200/5	-	-	20	20	-
800	700kVA (1014A)	Rating (I_n) = 1250A I _r = 1125A (0.9xI _n) t _r = 2s (at 6xI _r) I _{sd} = 2250A (2xI _r) t _{sd} = 0.1s, I ² t off I _i = 5000A (4xI _n)	1200/5	-	-	20	20	-
800	800kVA (1159A)	Rating (I_n) = 1250A I _r = 1187A (0.95xI _n) t _r = 2s (at 6xI _r) I _{sd} = 2375A (2xI _r) t _{sd} = 0.1s, I ² t off I _i = 5000A (4xI _n)	1200/5	-	-	20	20	-
1000	200kVA (289A)	Rating (I_n) = 800A I _r = 320A (0.4xI _n) t _r = 2s (at 6xI _r) I _{sd} = 2560A (8xI _r) t _{sd} = 0.1s, I ² t off I _i = 8000A (10xI _n)	800/5	-	20	-	20	-
1000	300kVA (434A)	Rating (I_n) = 800A I _r = 480A (0.6xI _n) t _r = 2s (at 6xI _r) I _{sd} = 2400A (5xI _r) t _{sd} = 0.1s, I ² t off I _i = 8000A (10xI _n)	800/5	-	20	-	20	-

Table 4 Cable Requirements For Arrangement 4

Transformer Size (kVA)	Load (Amps)	Metering MCCB Trip Unit Settings	Metering CT Ratio	Maximum Circuit Length (m)				
				4 x 600 solidals	4 x 740 solidals	7 x 600 solidals	7 x 740 solidals	11 x 740 solidals
1000	400kVA (579A)	Rating (I_n) = 800A I _r = 640A (0.8xI _n) t _r = 2s (at 6xI _r) I _{sd} = 2560A (4xI _r) t _{sd} = 0.1s, I ² t off I _i = 8000A (10xI _n)	800/5	-	20	-	20	-
1000	500kVA (724A)	Rating (I_n) = 800A I _r = 760A (0.95xI _n) t _r = 2s (at 6xI _r) I _{sd} = 2280A (3xI _r) t _{sd} = 0.1s, I ² t off I _i = 8000A (10xI _n)	800/5	-	20	-	20	-
1000	600kVA (869A)	Rating (I_n) = 1250A I _r = 875A (0.7xI _n) t _r = 2s (at 6xI _r) I _{sd} = 2625A (3xI _r) t _{sd} = 0.1s, I ² t off I _i = 7500A (6xI _n)	1200/5	-	-	-	20	-
1000	700kVA (1014A)	Rating (I_n) = 1250A I _r = 1125A (0.95xI _n) t _r = 2s (at 6xI _r) I _{sd} = 2250A (2xI _r) t _{sd} = 0.1s, I ² t off I _i = 7500A (6xI _n)	1200/5	-	-	-	20	-
1000	800kVA (1159A)	Rating (I_n) = 1250A I _r = 1250A (1.0xI _n) t _r = 2s (at 6xI _r) I _{sd} = 2500A (2xI _r) t _{sd} = 0.1s, I ² t off I _i = 7500A (6xI _n)	1200/5	-	-	-	20	-

Table 4 Cable Requirements For Arrangement 4

Transformer Size (kVA)	Load (Amps)	Metering MCCB Trip Unit Settings	Metering CT Ratio	Maximum Circuit Length (m)				
				4 x 600 solidals	4 x 740 solidals	7 x 600 solidals	7 x 740 solidals	11 x 740 solidals
1000	900kVA (1304A)	Rating (I_n) = 1600A $I_r = 1440A (0.9xI_n)$ $t_r = 2s$ (at $6xI_r$) $I_{sd} = 2880A (2xI_r)$ $t_{sd} = 0.1s, I^2t$ off $I_i = 6400A (4x I_n)$ $I_g = 1200A$ (setting D) $t_g = 0.4s, I^2t$ on	1600/5	-	-	-	-	20
1000	1000kVA (1449A)	Rating (I_n) = 1600A $I_r = 1520A (0.95xI_n)$ $t_r = 2s$ (at $6xI_r$) $I_{sd} = 3040A (2xI_r)$ $t_{sd} = 0.1s, I^2t$ off $I_i = 6400A (4x I_n)$ $I_g = 1200A$ (setting D) $t_g = 0.4s, I^2t$ on	1600/5	-	-	-	-	20

Table 5 Summary of Arrangements 1 to 4

LOAD	Arrangement 1	Arrangement 2	Arrangement 3	Arrangement 4
100kVA (144A)	Applicable to loads between 69kVA and 259kVA (or up to 300kVA where Winter cable ratings can be utilised)			
150kVA (217A)		For 315kVA and 500kVA transformers where LV fuse does not grade with HV protection.		
200kVA (289A)				
250kVA (362A)				
300kVA (434A)				
350kVA (507A)				
400kVA (579A)			Used for large LV loads with solidals longer than 20m	Used for large LV loads with solidals up to 20m in length.
450kVA (652A)				
500kVA (724A)				
550kVA (797A)				
600kVA (869A)				
650kVA (942A)				
700kVA (1014A)				
750kVA (1087A)				
800kVA (1159A)				
850kVA (1232A)				
900kVA (1304A)				
950kVA (1377A)				
1000kVA (1449A)				

3.0 CABLES

The standard arrangements utilise cable types and sizes currently available for use within WPD. The cable type used for any particular arrangement will depend on the cable rating, and the length of cable required.

Cable ratings depend on the:

- Medium in which they are laid (direct in ground, ducts, in air)
- Spacing between cables.
- Laying configuration, in the case of solidals (trefoil or flat)
- Time of year of the maximum demand (summer, winter)
- Load balancing.

Tables 1 to 4 assume that:

- Cables are laid direct in the ground.
- Maximum load occurs in the summer period.
- Load is balanced.
- Harmonic content of load is negligible.

Further information on cable ratings is provided in the latest version of ST:SD8B and in Appendix A of this document. Guidance on disturbing bad, including harmonics and flicker, will be included in ST:SD6F, once issued.

3.1 3 Phase Wavecon Cables

When wavecon cables are specified, 3 core types shall normally be installed. On the rare occasions where a separate neutral and earth (SNE) supply is required, 4 core wavecon cables may be substituted. Under no circumstances shall 3 phase cables be bunched, i.e. operated in parallel.

3.2 Solidal Cables

Only armoured type, solidal cables shall be used. Solidal ratings and laying configurations are specified in Appendix A.

Whenever possible solidals shall be laid in a trefoil rather than flat configuration. This arrangement provides a higher current rating and occupies less space.

Whichever laying configuration is used, the armour is bonded to neutral at the Metering MCCB end and left floating at the transformer cabinet end. This prevents current from being induced in the armour and also ensures that any current in the neutral (due to load unbalance or harmonics) does not pass through the armour.

Insulated wrap is applied to any exposed armour at the substation earth to prevent inadvertent contact. The specification for this wrap is provided in Appendix D.

4.0 CIRCUIT BREAKERS

Some LV arrangements require the use of one or more LV circuit breakers. These shall comply with the latest version of EE:SPEC 16 or EE:SPEC 28 as appropriate. When a metering circuit breaker is required this shall be owned and maintained by WPD. At the time of issue of this document WPD's standard circuit breakers and tripping units are as follows. Appendix C and E provide further details of this equipment.

- Merlin Gerin NS800 MCCB with Micrologic 5.0 trip unit
- Merlin Gerin NS1250 MCCB with Micrologic 5.0 trip unit
- Merlin Gerin NS1600 MCCB with Micrologic 6.0A trip unit.

When circuit breakers are to be purchased and/or installed by the customer or the customers appointed contractor, under Competition in Connections rules, alternative makes/types of circuit breaker and tripping unit may be offered. Alternative equipment is acceptable as long as it satisfies the latest issue of WPD's specification EE:SPEC 28 or EE:SPEC 16 as appropriate and is approved for use by the Policy Section.

Protection settings for standard circuit breaker tripping units are specified in the Appendices. If non-standard circuit breakers and tripping units are used or if the customer has other specific requirements, advice shall be sought from Primary Design.

4.1 Emergency / Remote Tripping

Metering MCCB panels complying with the latest version EE:SPEC 28 have a trip button positioned on the front of the panel to allow the circuit breaker to be manually tripped under emergency conditions.

The mechanism is designed so that MCCB can only be reset and closed following the removal of a WPD system padlock. This should only be carried out by WPD staff.

In some cases the customer may wish to trip WPD's metering MCCB remotely, either from a remote emergency trip button or from their protection systems. WPD's metering MCCB has a 230V a.c. shunt trip coil fitted as standard that can be used by the customer for remote emergency tripping purposes. A typical arrangement is shown in Figure 5. It is important that links are installed on the MCCB panel to allow isolation of the customer's 230V tripping supply. These links should be clearly labelled "emergency tripping".

FIGURE 5
Remote Emergency Tripping

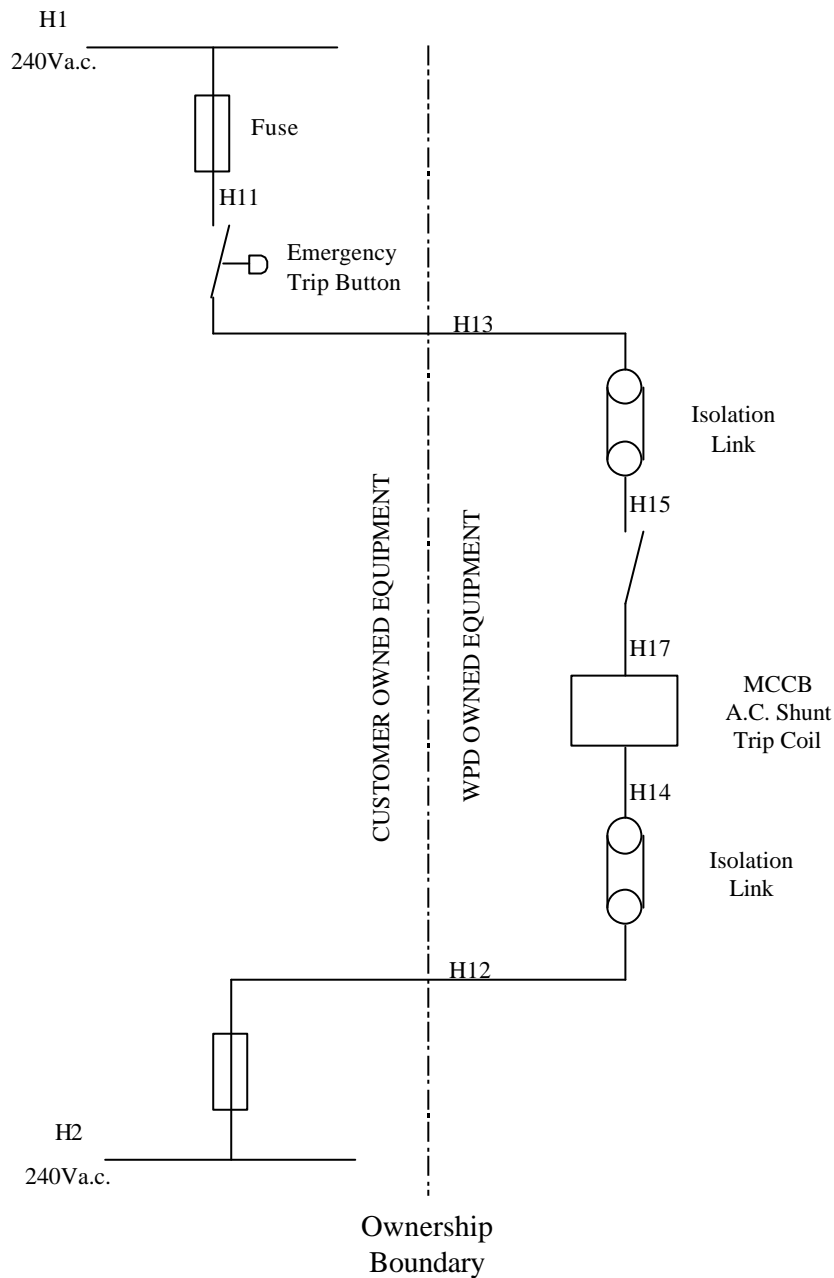

If the customer wishes to trip WPD's MCCB from their protection, the Planner shall first consider the following issues:

- Any additional circuit breaker duty/ number of operations
- Additional commissioning and maintenance requirements
- Reliability of customer's protection systems and equipment.
- Rating and reliability of customer's tripping supply.

Such a proposal is only acceptable if it does not adversely effect the operation, maintenance and reliability of WPDs equipment. Further guidance can be provided by HV Planners, Primary Design and, when necessary, the author of this document.

Any customer trip relay or other protection used to directly trip the metering circuit breaker shall satisfy the requirements of IEC 60255.

It is not recommended that a 230V a.c. LV supply is used for protection tripping, unless the customer has taken precautions to maintain the supply under fault conditions, for example by installing an adequate uninterruptible power supply (UPS).

If an alternative tripping supply is proposed by the customer, for example 24V d.c., a non-standard shunt trip coil shall be specified by the planner at the time of order of the MCCB. Under no circumstances shall an under voltage release coil be installed on WPD MCCBs. It should be noted that WPD do not hold replacements in stock for any non-standard items.

5.0 EARTHING

Earthing requirements for the HV and LV system are specified in ST:TP21P. Some additional guidance is included below.

5.1 Substation Earthing

When the combined resistance of a substation HV and LV earths is less than 1 ohm and also the rise of earth potential on the earthing system is less than 430V for high voltage faults, the HV and LV earths can be combined. If these conditions cannot be satisfied then the HV and LV earths must be segregated by at least 9m.

If segregation is required the HV earth electrode must be installed at least 9m from other buried metalwork, services and steel framed buildings. The HV earth electrode must be installed locally to the substation (to safeguard operators against hazardous potentials during HV earth faults) and so the substation location must be carefully selected to ensure segregation is maintained.

5.2 LV Earthing

Protective multiple earthing (PME) or protective neutral bonding (PNB) arrangements shall be provided to customers installations, unless there are good technical reasons for doing otherwise. PNB earthing is applicable where only one customer is connected to a given transformer and provides advantages where HV and LV transformer earths need to be segregated.

ST:TP21P provides guidance on the application of PME earthing and specifies alternative arrangements where PME cannot be offered. PME must not be provided where connections are provided to:

- Petrol filling stations
- Milking parlours
- Caravans
- Boats
- Temporary connections to construction sites
- Mines and quarries
- Communication masts and antennae

5.3 Earthing of Solidal Arrangements

The bonding requirements for solidal cables shall be in accordance with Section 3.2. Diagrams specifying the requirements for PME, PNB and SNE earthing are provided in Appendix B

6.0 GENERATION

Any customer standby or parallel generation, shall satisfy the requirements of EA Engineering Recommendation G59/1, G77/1, G83 and Engineering Technical Report (ETR) 113, as applicable.

When required, guidance on the connection of embedded generation can be obtained from the HV Planner and where necessary Primary Design. Records of all parallel generation are held by Primary Design. Details of any such schemes shall be copied to Primary Design for their records.

7.0 METERING

All metering referred to in this policy is current transformer (CT) metering. The appropriate CT ratio for each arrangement is given in the relevant table.

All CT's shall be class 0.5s to BS EN 60044-1. The CT ratio shall be chosen to reflect the highest prospective load on the circuit. Standard CT ratios include 200/5, 400/5, 800/5, 1000/5, 1200/5 and 1600/5

Further details regarding the metering for these arrangements can be found in the ST: MI13D and ST: MI13E.

Figure 6 shows typical metering arrangements for connections derived from Wavecon cables.

A drawing of a showing typical draw pit dimensions for use with the metering MCCB cabinet is shown in Figure 7. Note that the dimensions of the pit may vary depending on the number of cables and number and directions of incoming ducts.

FIGURE 6 Typical Metering Arrangement For Wavecon cable

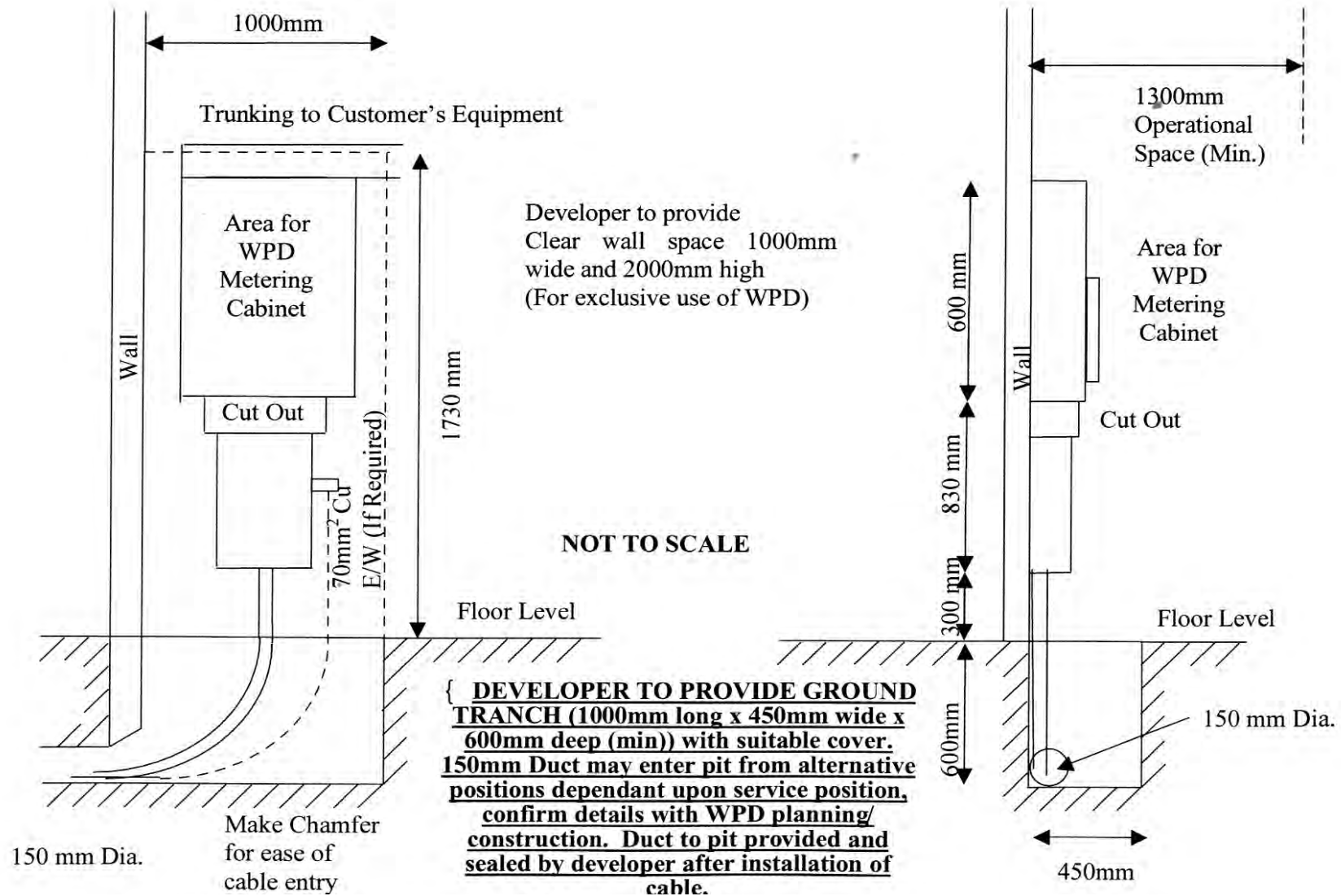
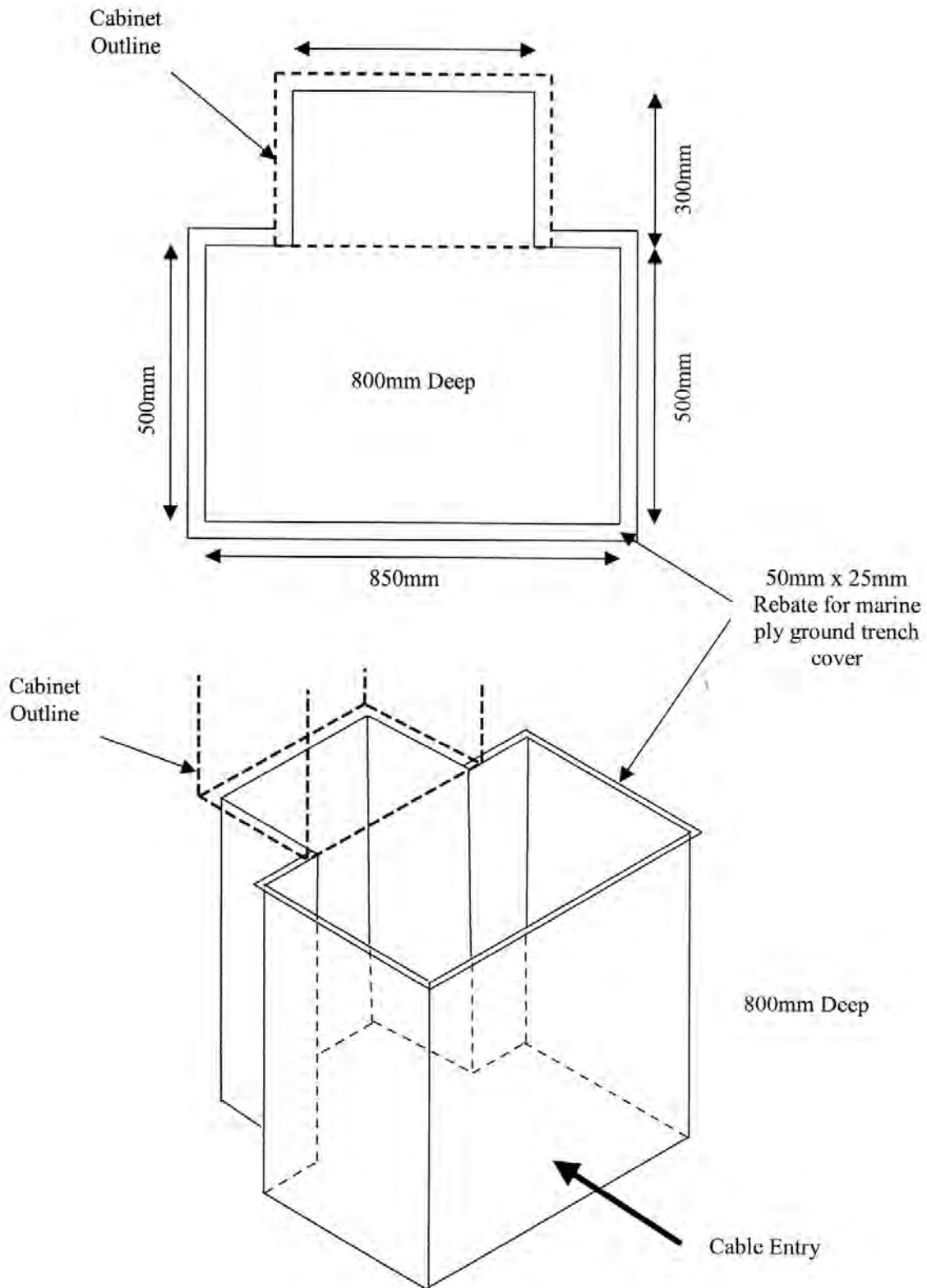

FIGURE 7 Typical Draw Pit for use with the Metering MCCB Cabinet

Note: Dimensions are suitable for most 4 and 7 solidal arrangements. The size may need to be increased where 11 solidals are installed depending on the number and direction of incoming ducts.



8.0 MULTIPLE CONNECTIONS TO A SINGLE CUSTOMER

The preferred arrangement is for each customer to have one connection per site but in some cases, for example where the site is spread over a large area, or where an enhanced supply security is needed, additional connections may be required.

Where this is the case the customer must take precautions to prevent the connections from being paralleled. Precautions may include:

- Physical separation of the LV systems supplied by each connection (e.g. separate buildings supplied by each connection with no interconnection) or
- Use of a break before make changeover switchgear, or
- Use of a mechanical interlocking.

Changeover arrangements relying on electrical interlocking can also be accepted if the customer can demonstrate the system is fail-safe. Software interlocking is not acceptable.

Where more than one supply is provided to a customer, labels shall be installed at the WPD intake warning of multiple feeds and describing the location of the other points of isolation.

APPENDIX A TO ANNEX D

ARMoured SOILDAL CABLE CONFIGURATIONS AND RATINGS

All ratings for armoured solidals are based on the following criteria

- Continuous summer ratings (24 hours a day, 7 days a week)
- $Tr = 1.2\text{Km/W}$
- Ground Temperature 15°C
- Ambient air temperature 25°C
- Depth of lay 0.8m
- Armour bonded to earth at metering MCCB only

FIGURE A1 Trefoil Configuration – laid direct in ground or in air

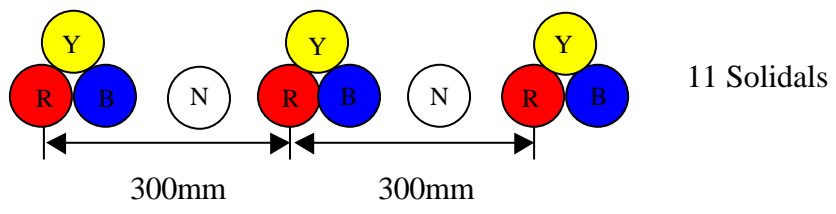
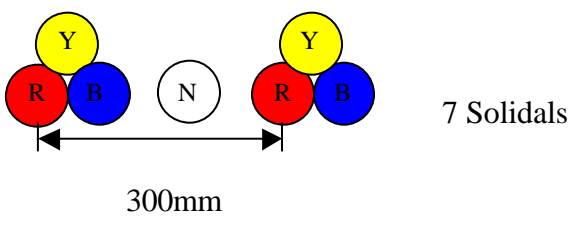
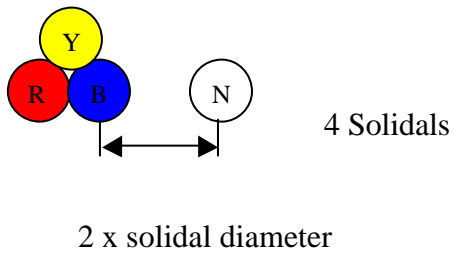

FIGURE A2 Flat Configuration – laid direct in ground or in air

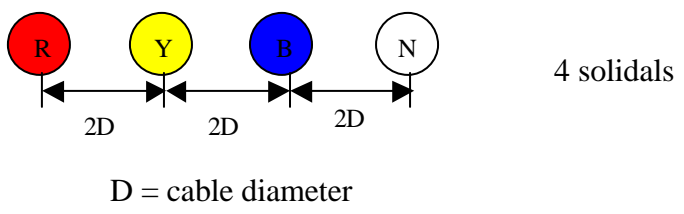
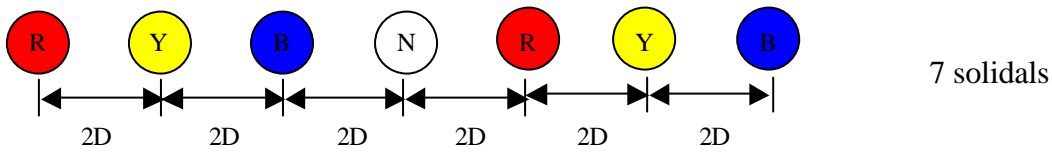
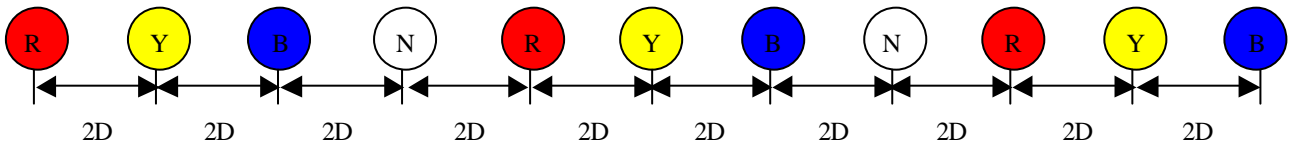

FIGURE A2 (Continued) Flat Configuration – laid direct in ground or in air



D = cable diameter



D = cable diameter

FIGURE A3 Trefiol Configuration – laid in ducts

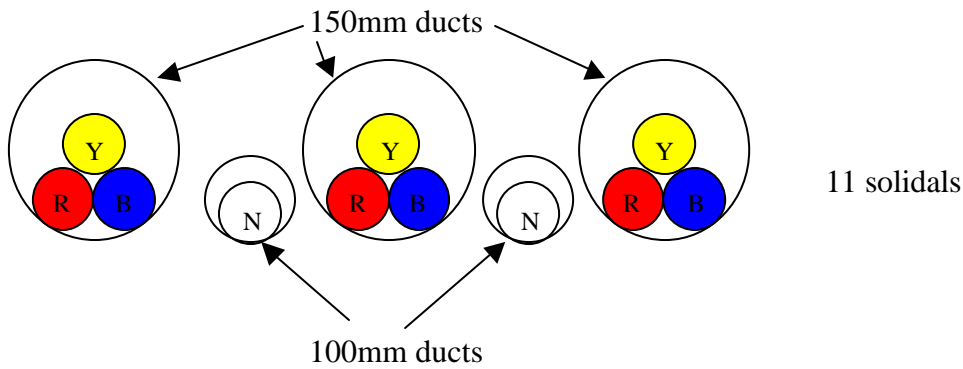
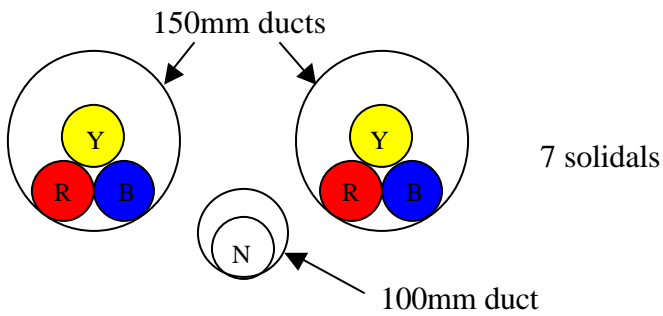
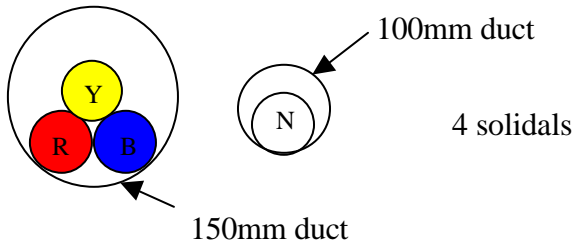

FIGURE A4 Flat Configuration – laid in ducts

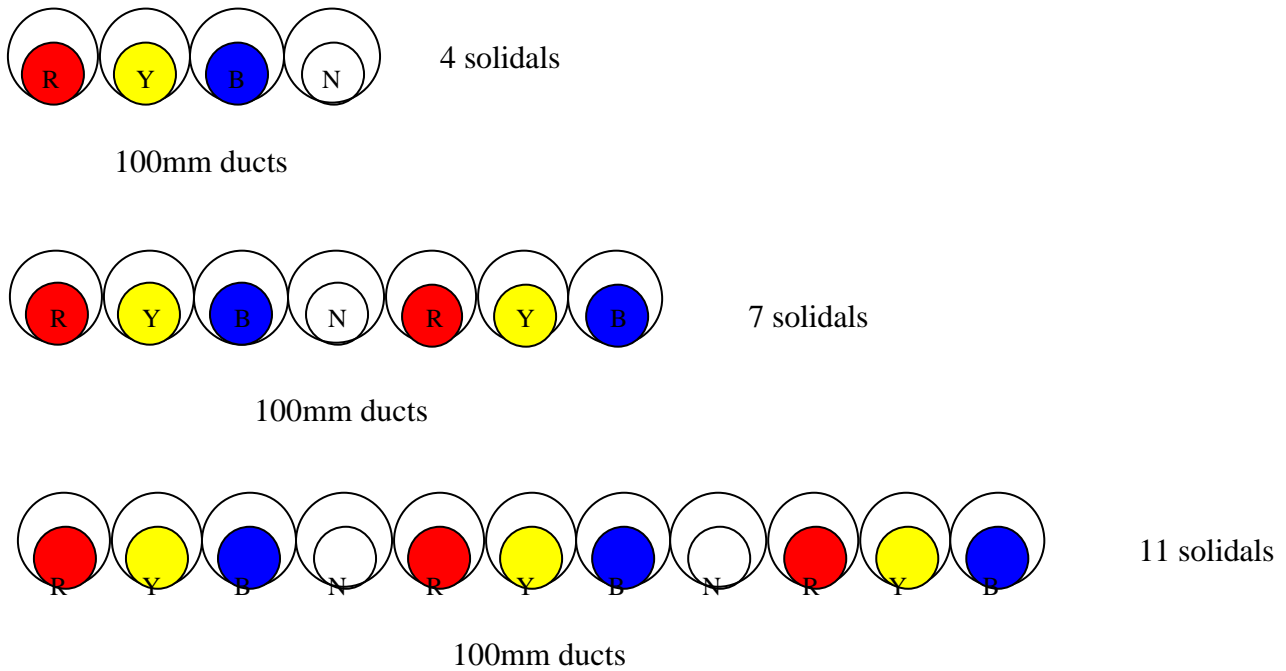

TABLE A1 Solidal Cable Ratings

Solidal Cable Size and Configuration	Cable Rating		
	Direct in ground ^[2]	In Air ^[1]	In Ducts ^[2]
Trefoil Configuration			
4 x 600mm ²	672	785	556
4 x 740mm ²	783	879	591
7 x 600mm ²	1160	1570	1016
7 x 740mm ²	1260	1758	1100
11 x 600mm ²	1560	2355	1395
11 x 740mm ²	1680	2637	1515
Flat Configuration			
4 x 600mm ²	619	871	556
4 x 740mm ²	655	933	591
7 x 600mm ²	1070	1742	1030
7 x 740mm ²	1160	1866	1090
11 x 600mm ²	1500	2613	1440
11 x 740mm ²	1575	2799	1530

Note 1: Enhanced ratings for installation “in air” can only be used where the entire cable route is in air.

Note 2: When a cable is laid partly in the ground and partly in ducts, the “in ducts” rating applies where either >15m or >50% of the cable route is in ducts.

FIGURE B1 Solidal Bonding Requirements – Arrangement 3 with combined HV/LV earthing and a PME connection

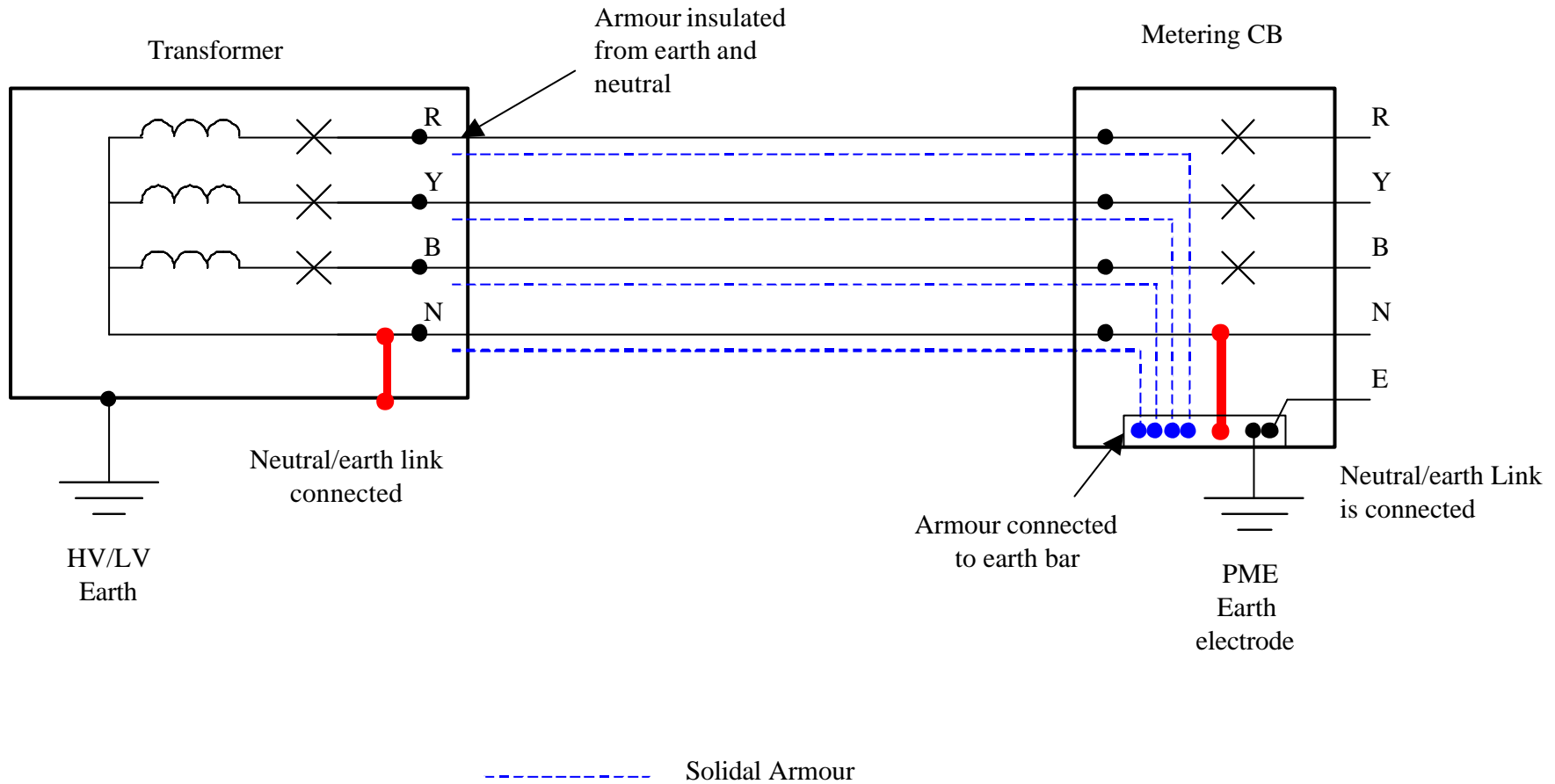
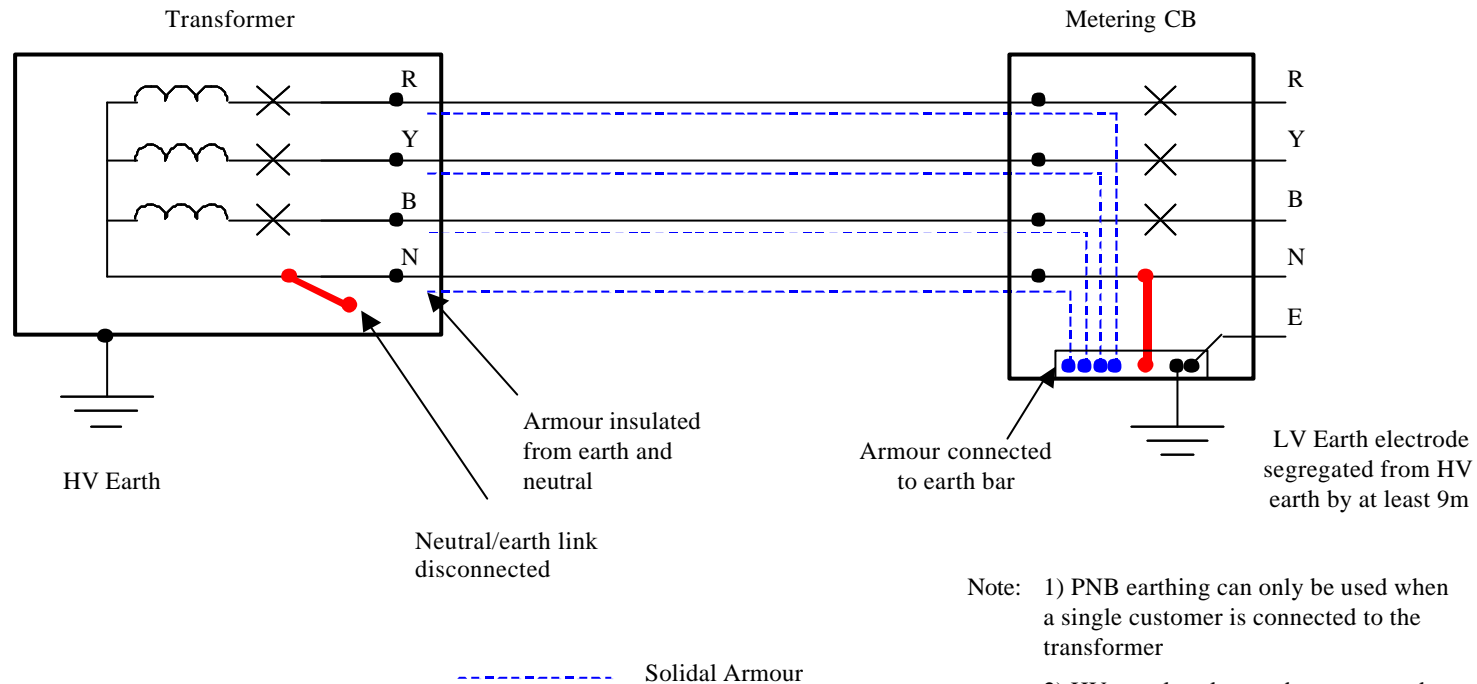
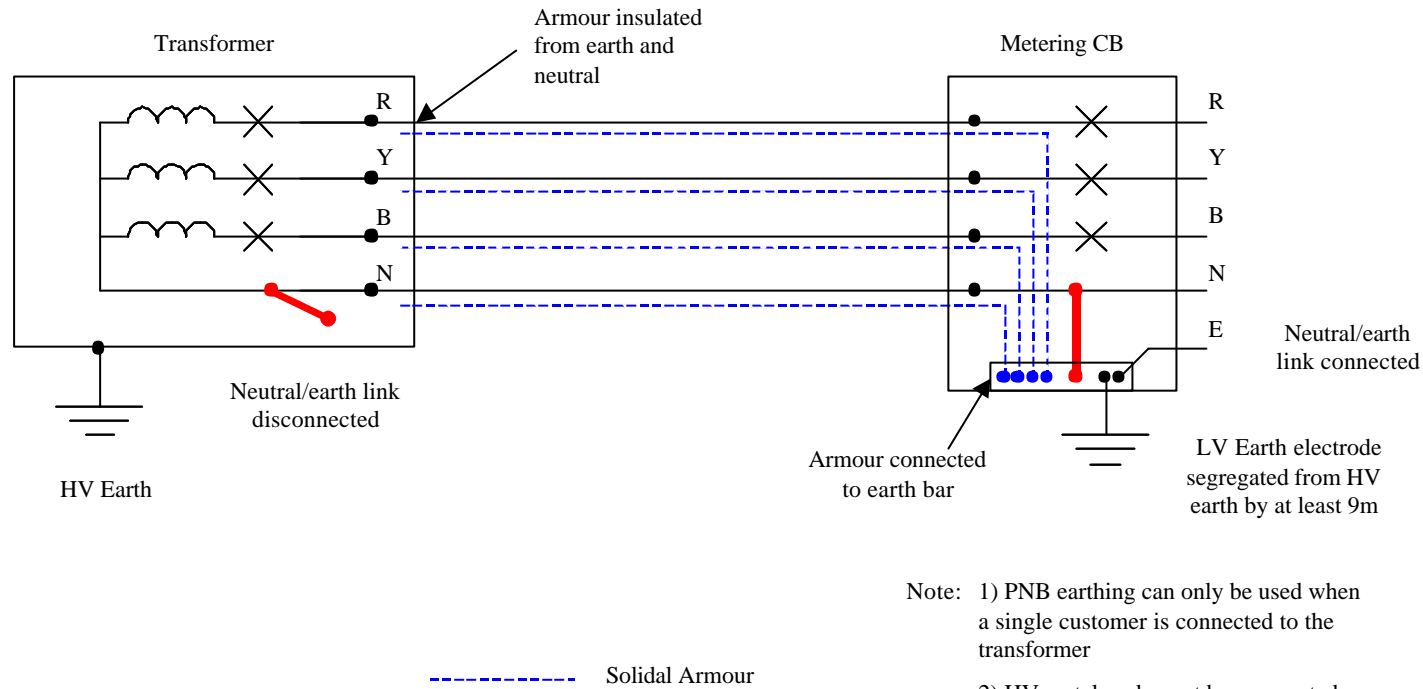

FIGURE B2 Solidal Bonding Requirements – Arrangement 3 with segregated HV/LV earthing and a PME connection



- Note:
- 1) PNB earthing can only be used when a single customer is connected to the transformer
 - 2) HV metalwork must be segregated by at least 2m from other metalwork, to prevent hazardous touch potentials.
 - 3) A distance of at least 9m must be maintained between buried services / metalwork and the buried HV earth electrode.

FIGURE B3 Solidal Bonding Requirements – Arrangement 3 with segregated HV/LV earthing and a PNB connection



- Note:
- 1) PNB earthing can only be used when a single customer is connected to the transformer
 - 2) HV metalwork must be segregated by at least 2m from other metalwork, to prevent hazardous touch potentials.
 - 3) A distance of at least 9m must be maintained between buried services / metalwork and the buried HV earth electrode.

FIGURE B4 Solidal Bonding Requirements – Arrangement 3 with combined HV/LV earthing and a SNE connection

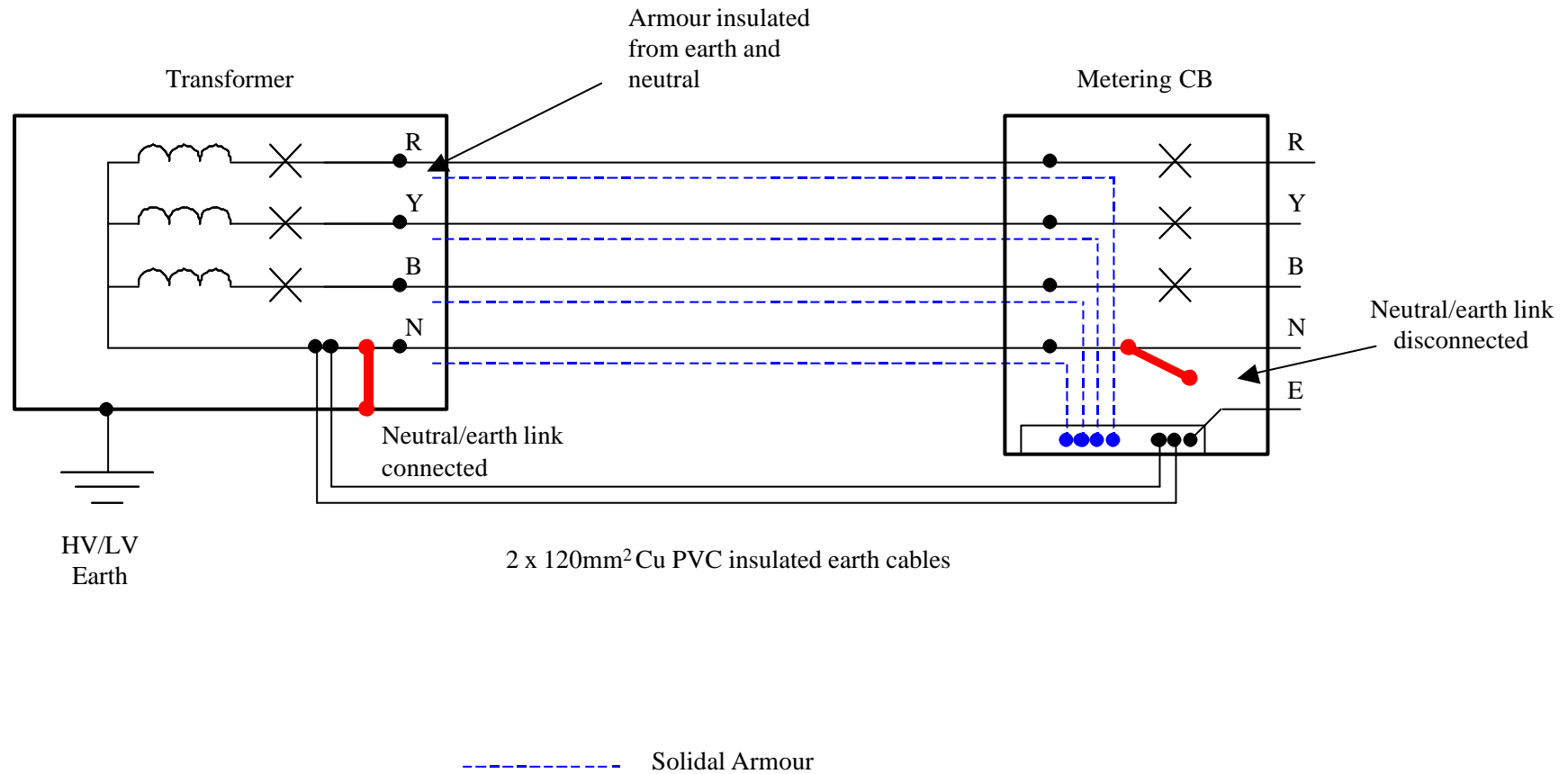
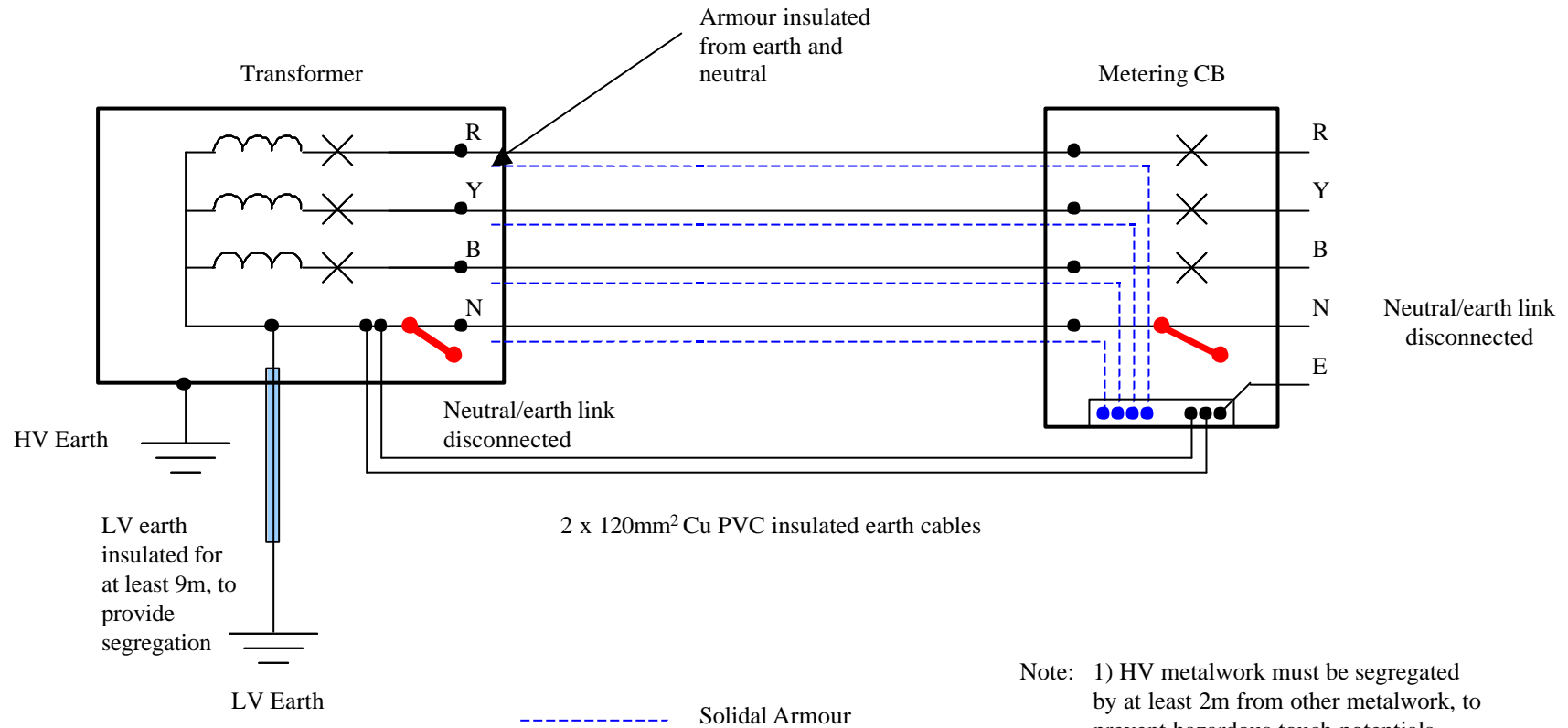
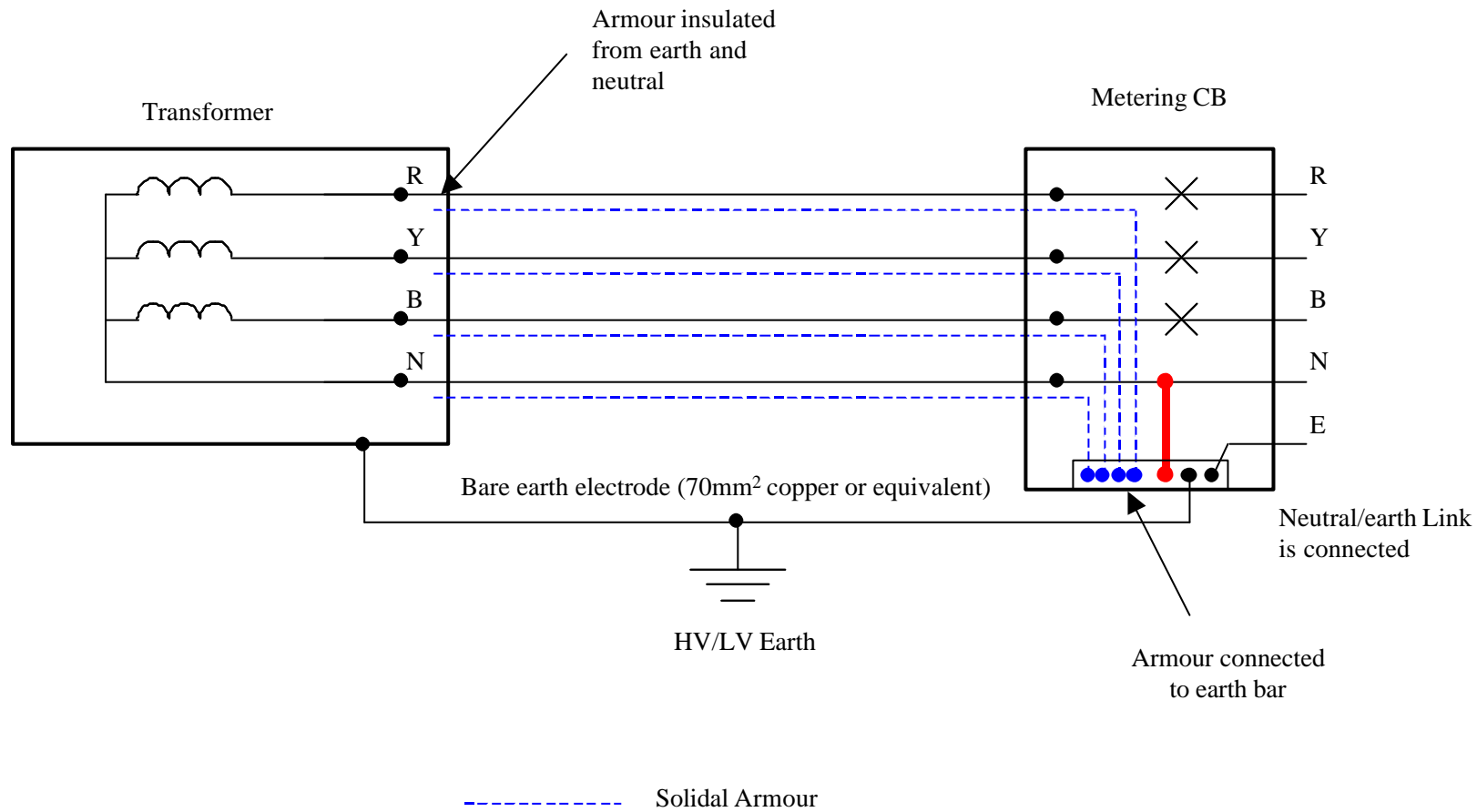

FIGURE B5 Solidal Bonding Requirements – Arrangement 3 with segregating HV/LV earthing and a SNE connection



- Note:
- 1) HV metalwork must be segregated by at least 2m from other metalwork, to prevent hazardous touch potentials.
 - 2) A distance of at least 9m must be maintained between buried services / metalwork and the buried HV earth electrode.

FIGURE B6 Solidal Bonding Requirements – Arrangement 4 with combined HV/LV earthing and a PNB connection



MICROLOGIC TRIPPING UNIT

The standard trip unit (protection relays) used with the 800A and 1250A MCCB is the Merlin Gerin Micrologic 5.0. The 1600A MCCB is fitted with a Micrologic 6.0A as standard.

Both these devices provide overcurrent protection and include a load setting, adjustable I^2t characteristics and two stages of fast operating protection. The characteristics and settings are shown in the following diagrams.

The Micrologic 6.0A trip unit also includes an earth fault element that detects current in the neutral and earth. This protection is typically set to the rating of the neutral cable with an operating time of approximately 0.4s.

A manufacturer's Micrologic user guide is available:

SUPPLEMENTARY INSULATION FOR SOLIDAL ARMOURING

SHOPS Item Number 35247

Cable wrapping for 20kV AC RMS insulation shall be as specified in the table below.

Manufacturer: ABB
Pack: RULLE 2
Material: EPDM + butyl rubber
Dimensions: Thickness 2mm, Width 60mm, Length 5.5m
Temperature Sensitivity: Constant 90°C, intermittent 125°C
DC Electrical Withstand: 25kV
AC Electrical Withstand: >20kV RMS 1 minute wrapped in 2 layers at 50% overlap
Suitable for laying in ground or water: Yes
Resistant to UV radiation: Yes
Shelf Life: At least 5 years
Impact Test: IEC 502 (draft)

SPECIFICATION FOR 433V INDOOR SERVICE TERMINATION UNITS

1. INTRODUCTION

- 1.1 This Technical Specification specifies requirements for Low Voltage Intake Panels used to provide a point of metering, isolation and protection to customers with large LV supplies up to 1443A.
- 1.2 The units are equipped with a Moulded Case Circuit Breaker or Air Circuit Breaker, arranged to provide a Customer's emergency trip. Provision is included for accommodation of metering potential fuses, CTs and associated CT terminations.

2. COMPLIANCE WITH STANDARDS

- 2.1 This Technical Specification makes reference to or implies reference to the following documents and it is important that users of all standards and Technical Specifications ensure that they are in possession of the latest issues together with any amendments. **Equipment shall comply with the listed standards unless otherwise specified to the contrary.**
- 2.2 This Technical Specification meets the requirements of clause 11 of The Utilities Supply and Works Contracts Regulations 1992 (Statutory Instrument 1992 No. 3279) dated 13 January 1993. British Standards which are the implementation of European Standards are listed in Part 2.3.

NB: A "European Standard" means a standard approved by the European Committee for Standardisation (CEN) or by the European Committee for Electrotechnical Standardisation (CENELEC) as a "European Standard" (EN) or a "Harmonisation Document" (HD) according to the Common Rules of those organisations or by the European Telecommunications Standards Institute (ETSI) according to its own rules as a "European Telecommunications Standard" (ETS).

2.3 EUROPEAN STANDARDS

Whilst the IEC base document is listed for information, the prime document which shall take priority is the British Standard enacting the European Standard (EN) or European Harmonisation Document (HD).

British Standard	EN/HD/ISO Reference	Title	IEC/ISO Base
BS88 Part 6		Cartridge Fuses for voltages up to and including 1000V a.c. and 1500V d.c.	
BSEN 60439		Low voltage switchgear and controlgear assemblies - Specification for type-tested and partially type-tested assemblies	IEC 60439-1
BSEN 60529		Specification for the degrees of protection provided by enclosures	IEC 60529
BSEN 60947		Specification for low-voltage switchgear and controlgear assemblies	IEC 60947
BSEN 60044-1		Instrument transformers Part 1 : Current Transformers	IEC 60044-1
British Standard	EN/HD/ISO Reference	Title	IEC/ISO Base
BS 7870 Part 3		LV & MV polymeric insulated cables for use by distribution and generation utilities	
BS7655 (1997)		Specification for insulating and sheathing materials for cables.	

2.4 EA TECHNICAL SPECIFICATIONS

Technical Specification	Title
EATS 50-18	Ancillary Equipment Cubicles etc

3. GENERAL ARRANGEMENT

- 3.1 The unit shall be floor mounted with bottom cable entry and shall be suitable for extension to form part of a multi-panel switchboard with a busbar configuration that can be extended on both the left and right sides. The size will be typically approximately 1500mm high, 600mm wide by 400mm deep, though Suppliers may submit alternative dimensions.
- 3.2 The equipment shall be designed for minimal and simple maintenance. Any parts requiring maintenance access shall not require disconnection of either of the incoming cables or busbars.

4. CABINET

- 4.1 The unit shall comply with EA TS 50-18 and be constructed from sheet steel.
- 4.2 Door panels shall be hinged and lockable which will be secured by the use of a WPD System/Safety padlock of the following size to be fitted - body up to 38mm square with a 7mm diameter shackle having a clear inside width of 20mm and an inside length of between 16mm and 30mm. The holes provided for the shackle to pass through shall be not less than 8mm diameter.

- 4.3 All doors and panels *which can be opened or removed externally* are to be provided with sealing facilities for WPD standard copper compression seals on steel wire. On panels the sealing fittings shall be placed on diagonal corners.
- 4.4 The cabinet shall have three segregated compartments:
- (a) The lower compartment shall house the incoming cable terminations and busbars to the rear/underside of the circuit breaker, which shall be flush mounted.
 - (b) The upper compartment shall house the outgoing busbars complete with removable busbar links (for fitting/changing current transformers) and suitable accommodation for metering current transformers (section 11). The compartment shall have large removable plates on the side to enable connection onto the busbar runs to the Customers switchgear. Such plates shall only be removable from the inside of the cabinet. The CTs shall be accessed from the front by means of an access panel having sealing facilities as specified in 4.3 above. It shall have adequate dimensions to allow the CTs to be easily installed or changed without disturbing adjacent parts of the unit.
 - (c) A separate fuse compartment (accessed by a lockable door) adjacent to the circuit breaker shall house the metering potential fuses, test terminal block, protection fuses (where fitted) and interlock key.
- 4.5 The segregation between upper and lower compartments shall be by means of a barrier to class IP3X. The segregation between the fuse compartment and the upper and lower compartments shall be not less than IP4X. Externally, the cabinet shall have overall protection approaching IP41, but not less than IP31. (BS EN 60529) Where appropriate the form of separation shall be Form 2A in accordance with BS EN 60439.
- 4.6 The cabinet shall be provided with ventilation (suitably baffled) providing class IP41 protection so as to comply with the temperature rise requirements of this specification (Section 11)
- 4.7 Metering potential fuses and CTs shall be readily accessible and replaceable without disconnection of incoming cables or busbars.
- 4.8 The insulating materials shall be non-flammable and non-hydroscopic and resistant to tracking as present manufacturing techniques allow.
- 4.9 Paintwork shall be light grey (Colour reference 631) in accordance with EA TS 50-18 unless otherwise agreed.
- 4.10 Suitable, tested, lifting eyes shall be provided to assist in the mechanical handling of the fully constructed cabinet.

5. **CIRCUIT BREAKER**

- 5.1 The circuit breaker shall be a 3 pole type for use on the 433V a.c. system satisfying the requirements of BS EN 60947-2: 1996, classified as follows:

- Air circuit breaker (ACB) or moulded case circuit breaker (MCCB)
 - Utilisation category B
 - Dependent manual operation
 - Suitable for isolation
 - Fixed installation
- 5.2 Minimum rated service short circuit breaking capacity (I_{cs}) shall be 35kA.
Minimum rated short time withstand current (I_{cw}) shall be 20kA for 1 second.
Rated Current for the circuit breaker and panel combination shall be 1600A, 1250A or 800A as specified at the time of tender.
- 5.3 A bolted neutral link shall be provided
- 5.4 The circuit breaker shall be equipped with integral, adjustable, phase fault protection with characteristics and setting ranges specified below:
- Overload characteristic, adjustable between 0.5 x and 1.0x circuit breaker Rated Current (at least 5 steps).
 - I^2t characteristic with time settings adjustable between 1 and 20s at 6x the overload setting (at least 4 steps).
 - A short time characteristic, selectable between definite time and I^2t with current setting adjustable between 2x and 8x overload setting (at least 5 steps) and with time setting adjustable between 0 and 0.4s (at least 4 steps).
 - An instantaneous characteristic with current setting adjustable between 2x and 10x the circuit breaker Rated Current (at least 5 steps).
- In addition to phase fault protection, 1600A circuit breakers shall be equipped with earth fault protection satisfying the following requirement:
- Earth fault characteristic selectable between definite time and I^2t with current setting adjustable between 600A and 1200A (at least 5 steps) and with time setting adjustable between 0 and 0.4s (at least 4 steps).
- 5.5 The circuit breaker and its associated protection features shall be suitably rated to meet the specified performance and temperature rise conditions in the PANEL ENCLOSURE SUPPLIED (i.e. not just in “free air” conditions.)
- 5.6 The circuit breaker shall have a 240V 50Hz shunt trip coil and auxiliary switch.
- 5.7 The method of closing the circuit breaker shall be by independent manual operation and the mechanism shall be of the trip-free type.
- 5.8 A facility must be provided to lock, with a padlock, the circuit breaker in either the closed or open position. The padlock used will be the System/Safety padlock specified in section 4.2 of this specification.

- 5.9 The equipment shall be arranged to permit the Customer to open the circuit breaker in order to disconnect the supply, but an interlock arrangement shall be provided to prevent reclosing of the circuit breaker by the Customer. This shall be achieved using a key type interlock arrangement where the key releases the auto-lock off. The interlock key shall be kept in the locked fuse compartment adjacent to the circuit breaker. (See 4.4 (c))

6. **SHORT CIRCUIT RATINGS**

- 6.1 The equipment contained within the intake panel shall be proven by test to be capable of carrying without undue distortion or deterioration the fault currents specified in Section 5 and in accordance with BSEN60439 PT1.

7. **INCOMING CABLE TERMINATIONS**

- 7.1 A cable support and a gland plate shall be provided, constructed from suitable non-ferrous materials (e.g. wood) to support the following arrangements of incoming cables:

800A and 1250A circuit breakers

4 x 600 mm² 'ARMOURED SOLIDAL' cable (1 per phase + 1 for neutral)
4 x 740 mm² 'ARMOURED SOLIDAL' cable (1 per phase + 1 for neutral)
7 x 600 mm² 'ARMOURED SOLIDAL' cable (2 per phase + 1 for neutral)
7 x 740 mm² 'ARMOURED SOLIDAL' cable (2 per phase + 1 for neutral)

1600A circuit breakers

7 x 600 mm² 'ARMOURED SOLIDAL' cable (2 per phase + 1 for neutral)
7 x 740 mm² 'ARMOURED SOLIDAL' cable (2 per phase + 1 for neutral)
11 x 600 mm² 'ARMOURED SOLIDAL' cable (3 per phase + 2 for neutral)
11 x 740 mm² 'ARMOURED SOLIDAL' cable (3 per phase + 2 for neutral)

In addition to the requirement above, provision must be made to accept 2 x 120 PVC covered earth cables.

- 7.2 Sheer bolt lugs shall be accommodated as the cable termination. Bolts, nuts, washers and lock washers are to be supplied, however the Purchaser will supply the lugs or connectors. Provision shall be made for the lug or connector to have a palm thickness of 10mm minimum. The busbar ends are to be drilled to accept either standard 4 hole (ARMOURED SOLIDAL) sheer bolt lugs with M8 bolts or 1 hole (Wavecon) sheer bolt lugs with M16 bolts. The distance between the cable gland plate and the lowest incoming busbar connection shall not be less than 550mm in order to allow for the cable bending radius for the above cables. The gland plate shall be sized near to the total floor area of the panel and shall be removable internally. Armoured 'SOLIDAL' cables are specified therefore a suitable earthed armour clamp shall be supplied.

8. **BUSBARS**

- 8.1 Busbars shall be of hard-drawn high conductivity copper or other material as approved by the purchaser. The normal rated current shall be equal to or greater than the circuit breaker rated current.
- 8.2 For busbars and busbar connections in air, the minimum electrical clearances and minimum creepage distances between phases and phase to earth, shall be a minimum of 19mm in accordance with EA TS 37-1.
- 8.3 The busbar arrangement shall provide for extension of the busbars to the left and/or to the right of the panel

9. **EARTHING**

- 9.1 Provision shall be made for the connection of either a Combined Neutral Earth (CNE) or Separate Neutral Earth (SNE). An additional earth at the top of the unit shall be provided for connection of customer earthing.
- 9.2 Manufacturers shall ensure earth continuity between panel sheets making up the enclosure, noting that some paint finishes have poor conductivity.

10. **CT MOUNTINGS & METERING CONNECTIONS**

- 10.1 Provision shall be made for the installation of 3 metering CTs on the load side of the circuit breaker, one per phase in the upper compartment. Suitable mounting arrangements shall be made to facilitate changing of CTs using the removable links in the busbars. CTs shall be situated on the busbars immediately above the circuit breaker.
- 10.2 Metering CTs fitted in the 800A circuit breaker shall be 800/5, in the 1250A circuit breaker 1200/5 and in the 1600A circuit breaker they shall be 1600/5 unless otherwise specified. They shall be class 0.5s with 10VA burdens in accordance with BSEN 60044-1, and shall be supplied and fitted with test certificates supplied.
- 10.3 Three insulated metering potential fuse carriers, fitted with 6A fuses to BS88 Part 6 ref f1, shall be positioned within the fuse compartment and as close as possible to each outgoing phase busbar. They shall be connected to the busbars by a minimum 10 mm² cross section insulated conductor, positioned and screened to ensure safe withdrawal and replacement with the supplies energised and the circuit breaker closed.
- 10.4 A test terminal block shall be supplied within the fuse compartment for the termination of CT and metering potential wiring and multicore wiring for connection to metering equipment by WPD staff in a panel external to the intake panel.
- 10.5 Test Certificates for the CT's shall be provided to meet requirements in the Meter Operator Code of Practice Agreements.

11. TEMPERATURE RISE

- 11.1 The unit shall be designed and assembled to ensure that there is no adverse thermal interaction between any of the components. Temperature rise test certificates for the complete panel shall be available on request. Temperature rise requirements shall satisfy the requirements of BS EN 60439 Pt1: 1994, BS EN 60947-2, BS EN 60439-1 and any electronic components shall not exceed their maximum operating temperature (ambient temperature of 35°C).

12. TYPE TESTS

- 12.1 Type testing shall be carried out in accordance with EA TS 37-1, BS EN 60439-1 and BS EN 60947-2.

13. LABELLING

- 13.1 The unit shall be provided with an external front mounted nameplate in accordance with BS EN 60439-1 clause 5 and shall include the following additional information:

- (i) Serial number (unique).
- (ii) Year of manufacture.
- (iii) Normal current rating of busbar.
- (iv) Normal and short circuit current ratings of Circuit Breaker.
- (v) Reference to this specification.
- (vi) Gross weight, when fully equipped (kg).
- (vii) Manufacturer's name and reference number.

- 13.2 CT details shall also be displayed on an external front mounted nameplate. The nameplate shall include the information specified in BSEN 60044-1.

- 13.3 The circuit breaker operating handle shall have the following positions clearly marked - 'ON', 'TRIPPED', 'ISOLATED'.

14. DRAWINGS

- 14.1 The Manufacturer shall submit general arrangement drawings for approval by WPD prior to commencing manufacture.

FIGURE E.1 – DIMENSIONED ARRANGEMENT OF WPD MCCB CUBICLE

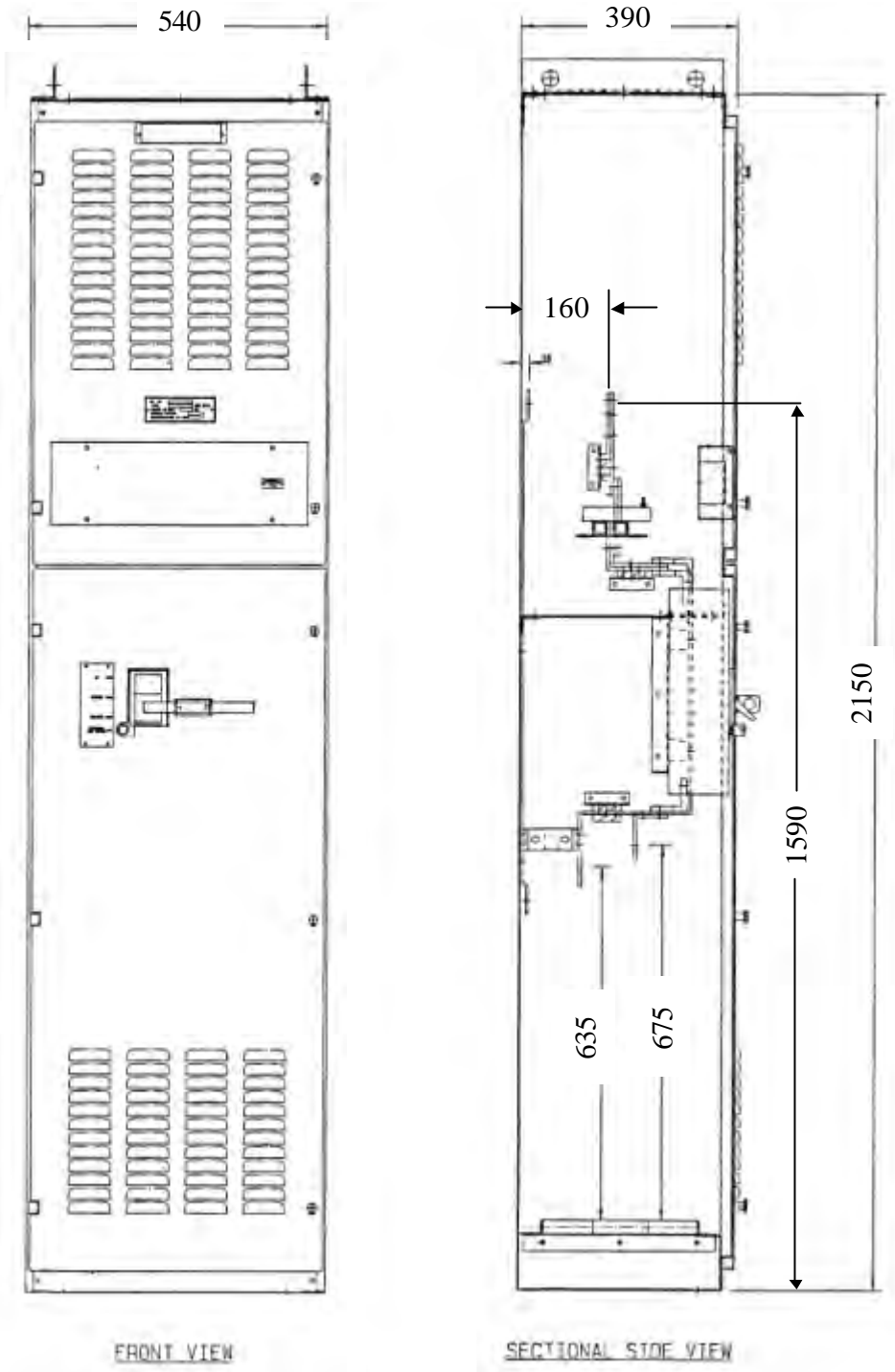

FIGURE E.4 Standard WPD Metering MCCB - busbar dimensions

